

**Processes**



Multiprocess Welding

**Description**



Arc Welding Power Source

# EX 360 FieldPro<sup>TM</sup> With Auto-Line<sup>TM</sup> And ArcReach<sup>®</sup>

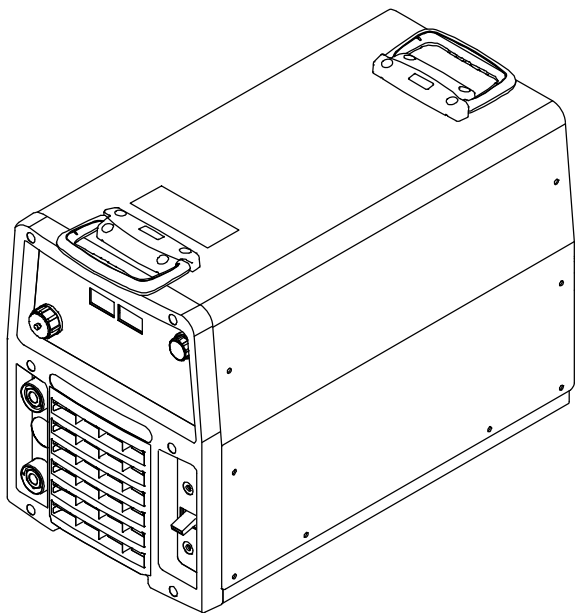

## OWNER'S MANUAL

File: MULTIPROCESS





# TABLE OF CONTENTS

<b>SECTION 1 – SAFETY PRECAUTIONS - READ BEFORE USING</b> .....	<b>1</b>
1-1. Symbol Usage .....	1
1-2. Arc Welding Hazards .....	1
1-3. Additional Symbols For Installation, Operation, And Maintenance .....	3
1-4. California Proposition 65 Warnings .....	4
1-5. Principal Safety Standards .....	4
1-6. EMF Information .....	4
<b>SECTION 2 – CONSIGNES DE SÉCURITÉ – LIRE AVANT UTILISATION</b> .....	<b>5</b>
2-1. Symboles utilisés .....	5
2-2. Dangers relatifs au soudage à l'arc .....	5
2-3. Dangers supplémentaires en relation avec l'installation, le fonctionnement et la maintenance .....	7
2-4. Proposition californienne 65 Avertissements .....	8
2-5. Principales normes de sécurité .....	8
2-6. Informations relatives aux CEM .....	8
<b>SECTION 3 – DEFINITIONS</b> .....	<b>9</b>
3-1. Additional Safety Symbols And Definitions .....	9
3-2. Miscellaneous Symbols And Definitions .....	11
<b>SECTION 4 – SPECIFICATIONS</b> .....	<b>12</b>
4-1. Features And Benefits .....	12
4-2. Arc Controls .....	12
4-3. Serial Number And Rating Label Location .....	12
4-4. Unit Specifications .....	12
4-5. Dimensions And Weight .....	13
4-6. Environmental Specifications .....	13
4-7. Duty Cycle And Overheating .....	14
4-8. Volt-Ampere Curves .....	15
<b>SECTION 5 – INSTALLATION</b> .....	<b>16</b>
5-1. Selecting A Location .....	16
5-2. Selecting Cable Sizes* .....	17
5-3. Weld Output Terminals .....	17
5-4. Remote 14 Receptacle Information .....	18
5-5. Supplementary Protector .....	18
5-6. Optional Gas Valve Operation And Shielding Gas Connection .....	19
5-7. Electrical Service Guide .....	20
5-8. Connecting 1-Phase Input Power .....	22
5-9. Connecting 3-Phase Input Power .....	24
<b>SECTION 6 – OPERATION</b> .....	<b>26</b>
6-1. Front Panel Controls .....	26
6-2. Mode Switch Settings .....	27
6-3. Associating ArcReach Device To ArcReach Power Source .....	27
6-4. Powering An ArcReach Smart Feeder In Lift-Arc TIG Mode .....	27
<b>SECTION 7 – GTAW OPERATION</b> .....	<b>28</b>
7-1. Typical Connection For GTAW Process .....	28
7-2. Typical Connection For ArcReach Stick/TIG Remote (GTAW Process) .....	29
7-3. Lift-Arc TIG Welding Mode - GTAW Lift-Arc - Output On .....	30
7-4. TIG Welding Mode - GTAW - Remote ON/OFF .....	31

# TABLE OF CONTENTS

---

<b>SECTION 8 – GMAW/FCAW OPERATION</b> .....	<b>32</b>
8-1. Typical Connection For Remote Control Feeder GMAW/FCAW Process .....	32
8-2. MIG Welding Mode - GMAW/FCAW Remote ON/OFF .....	33
8-3. Typical Connection For Voltage-Sensing Feeder GMAW/FCAW, FCAW-S Process .....	34
8-4. V-Sense Feeder Welding Modes - GMAW/FCAW, FCAW-S Output ON .....	35
<b>SECTION 9 – SMAW/CAC-A OPERATION</b> .....	<b>36</b>
9-1. Typical Connection For SMAW And CAC-A Process .....	36
9-2. Typical Connection For ArcReach Stick/TIG Remote (SMAW And CAC-A Process) .....	37
9-3. Stick Welding Modes - SMAW EXX18, SMAW EXX10, CAC-A Gouge - Output ON .....	38
9-4. Low Open Circuit Voltage (OCV) .....	39
9-5. Alternate Configuration Functions .....	39
<b>SECTION 10 – MAINTENANCE &amp; TROUBLESHOOTING</b> .....	<b>40</b>
10-1. Routine Maintenance .....	40
10-2. Blowing Out Inside Of Unit .....	40
10-3. Help Displays .....	41
10-4. Troubleshooting .....	42
<b>SECTION 11 – ELECTRICAL DIAGRAM</b> .....	<b>44</b>
<b>SECTION 12 – PARTS LIST</b> .....	<b>46</b>
<b>SECTION 13 – OPEN SOURCE LICENSE NOTICES</b> .....	<b>49</b>

**Red-D-Arc**  
**Welderentals**  
1-866-RED-D-ARC      reddarc.com

# SECTION 1 – SAFETY PRECAUTIONS - READ BEFORE USING

som 2018-01

**⚠** Protect yourself and others from injury — read, follow, and save these important safety precautions and operating instructions.

## 1-1. Symbol Usage



**DANGER!** – Indicates a hazardous situation which, if not avoided, will result in death or serious injury. The possible hazards are shown in the adjoining symbols or explained in the text.



Indicates a hazardous situation which, if not avoided, could result in death or serious injury. The possible hazards are shown in the adjoining symbols or explained in the text.

**NOTICE** – Indicates statements not related to personal injury.

 Indicates special instructions.



This group of symbols means Warning! Watch Out! ELECTRIC SHOCK, MOVING PARTS, and HOT PARTS hazards. Consult symbols and related instructions below for necessary actions to avoid the hazards.

## 1-2. Arc Welding Hazards



The symbols shown below are used throughout this manual to call attention to and identify possible hazards. When you see the symbol, watch out, and follow the related instructions to avoid the hazard. The safety information given below is only a summary of the more complete safety information found in the Safety Standards listed in Section 1-5. Read and follow all Safety Standards.



Only qualified persons should install, operate, maintain, and repair this equipment. A qualified person is defined as one who, by possession of a recognized degree, certificate, or professional standing, or who by extensive knowledge, training and experience, has successfully demonstrated ability to solve or resolve problems relating to the subject matter, the work, or the project and has received safety training to recognize and avoid the hazards involved.



During operation, keep everybody, especially children, away.



### ELECTRIC SHOCK can kill.

Touching live electrical parts can cause fatal shocks or severe burns. The electrode and work circuit is electrically live whenever the output is on. The input power circuit and machine internal circuits are also live when power is on. In semiautomatic or automatic wire welding, the wire, wire reel, drive roll housing, and all metal parts touching the welding wire are electrically live. Incorrectly installed or improperly grounded equipment is a hazard.

- Do not touch live electrical parts.

- Wear dry, hole-free insulating gloves and body protection.
- Insulate yourself from work and ground using dry insulating mats or covers big enough to prevent any physical contact with the work or ground.
- Do not use AC weld output in damp, wet, or confined spaces, or if there is a danger of falling.
- Use AC output ONLY if required for the welding process.
- If AC output is required, use remote output control if present on unit.
- Additional safety precautions are required when any of the following electrically hazardous conditions are present: in damp locations or while wearing wet clothing; on metal structures such as floors, gratings, or scaffolds; when in cramped positions such as sitting, kneeling, or lying; or when there is a high risk of unavoidable or accidental contact with the workpiece or ground. For these conditions, use the following equipment in order presented: 1) a semiautomatic DC constant voltage (wire) welder, 2) a DC manual (stick) welder, or 3) an AC welder with reduced open-circuit voltage. In most situations, use of a DC, constant voltage wire welder is recommended. And, do not work alone!
- Disconnect input power or stop engine before installing or servicing this equipment. Lockout/tagout input power according to OSHA 29 CFR 1910.147 (see Safety Standards).

- Properly install, ground, and operate this equipment according to its Owner's Manual and national, state, and local codes.
- Always verify the supply ground – check and be sure that input power cord ground wire is properly connected to ground terminal in disconnect box or that cord plug is connected to a properly grounded receptacle outlet.
- When making input connections, attach proper grounding conductor first – double-check connections.
- Keep cords dry, free of oil and grease, and protected from hot metal and sparks.
- Frequently inspect input power cord and ground conductor for damage or bare wiring – replace immediately if damaged – bare wiring can kill.
- Turn off all equipment when not in use.
- Do not use worn, damaged, undersized, or repaired cables.
- Do not drape cables over your body.
- If earth grounding of the workpiece is required, ground it directly with a separate cable.
- Do not touch electrode if you are in contact with the work, ground, or another electrode from a different machine.
- Do not touch electrode holders connected to two welding machines at the same time since double open-circuit voltage will be present.
- Use only well-maintained equipment. Repair or replace damaged parts at once. Maintain unit according to manual.
- Wear a safety harness if working above floor level.
- Keep all panels and covers securely in place.
- Clamp work cable with good metal-to-metal contact to workpiece or worktable as near the weld as practical.
- Insulate work clamp when not connected to workpiece to prevent contact with any metal object.
- Do not connect more than one electrode or work cable to any single weld output terminal. Disconnect cable for process not in use.
- Use GFCI protection when operating auxiliary equipment in damp or wet locations.

### SIGNIFICANT DC VOLTAGE exists in inverter welding power sources AFTER removal of input power.

- Turn off unit, disconnect input power, and discharge input capacitors according to instructions in Manual before touching any parts.



### HOT PARTS can burn.

- Do not touch hot parts bare handed.
- Allow cooling period before working on equipment.
- To handle hot parts, use proper tools and/or wear heavy, insulated welding gloves and clothing to prevent burns.



### FUMES AND GASES can be hazardous.

Welding produces fumes and gases. Breathing these fumes and gases can be hazardous to your health.

- Keep your head out of the fumes. Do not breathe the fumes.
- Ventilate the work area and/or use local forced ventilation at the arc to remove welding fumes and gases. The recommended way to determine adequate ventilation is to sample for the composition and quantity of fumes and gases to which personnel are exposed.
- If ventilation is poor, wear an approved air-supplied respirator.
- Read and understand the Safety Data Sheets (SDSs) and the manufacturer's instructions for adhesives, coatings, cleaners, consumables, coolants, degreasers, fluxes, and metals.
- Work in a confined space only if it is well ventilated, or while wearing an air-supplied respirator. Always have a trained watchperson nearby. Welding fumes and gases can displace air and lower the oxygen level causing injury or death. Be sure the breathing air is safe.
- Do not weld in locations near degreasing, cleaning, or spraying operations. The heat and rays of the arc can react with vapors to form highly toxic and irritating gases.
- Do not weld on coated metals, such as galvanized, lead, or cadmium plated steel, unless the coating is removed from the weld area, the area is well ventilated, and while wearing an air-supplied respirator. The coatings and any metals containing these elements can give off toxic fumes if welded.



### ARC RAYS can burn eyes and skin.

Arc rays from the welding process produce intense visible and invisible (ultraviolet and infrared) rays that can burn eyes and skin. Sparks fly off from the weld.

- Wear an approved welding helmet fitted with a proper shade of filter lenses to protect your face and eyes from arc rays and sparks when welding or watching (see ANSI Z49.1 and Z87.1 listed in Safety Standards).
- Wear approved safety glasses with side shields under your helmet.
- Use protective screens or barriers to protect others from flash, glare and sparks; warn others not to watch the arc.
- Wear body protection made from durable, flame-resistant material (leather, heavy cotton, wool). Body protection includes oil-free clothing such as leather gloves, heavy shirt, cuffless trousers, high shoes, and a cap.



### WELDING can cause fire or explosion.

Welding on closed containers, such as tanks, drums, or pipes, can cause them to blow up. Sparks can fly off from the welding arc. The flying sparks, hot workpiece, and hot equipment can cause fires and burns. Accidental contact of electrode to metal objects can cause sparks, explosion, overheating, or fire. Check and be sure the area is safe before doing any welding.

- Remove all flammables within 35 ft (10.7 m) of the welding arc. If this is not possible, tightly cover them with approved covers.
- Do not weld where flying sparks can strike flammable material.
- Protect yourself and others from flying sparks and hot metal.
- Be alert that welding sparks and hot materials from welding can easily go through small cracks and openings to adjacent areas.
- Watch for fire, and keep a fire extinguisher nearby.
- Be aware that welding on a ceiling, floor, bulkhead, or partition can cause fire on the hidden side.

- Do not cut or weld on tire rims or wheels. Tires can explode if heated. Repaired rims and wheels can fail. See OSHA 29 CFR 1910.177 listed in Safety Standards.
- Do not weld on containers that have held combustibles, or on closed containers such as tanks, drums, or pipes unless they are properly prepared according to AWS F4.1 and AWS A6.0 (see Safety Standards).
- Do not weld where the atmosphere can contain flammable dust, gas, or liquid vapors (such as gasoline).
- Connect work cable to the work as close to the welding area as practical to prevent welding current from traveling long, possibly unknown paths and causing electric shock, sparks, and fire hazards.
- Do not use welder to thaw frozen pipes.
- Remove stick electrode from holder or cut off welding wire at contact tip when not in use.
- Wear body protection made from durable, flame-resistant material (leather, heavy cotton, wool). Body protection includes oil-free clothing such as leather gloves, heavy shirt, cuffless trousers, high shoes, and a cap.
- Remove any combustibles, such as a butane lighter or matches, from your person before doing any welding.
- After completion of work, inspect area to ensure it is free of sparks, glowing embers, and flames.
- Use only correct fuses or circuit breakers. Do not oversize or bypass them.
- Follow requirements in OSHA 1910.252 (a) (2) (iv) and NFPA 51B for hot work and have a fire watcher and extinguisher nearby.
- Read and understand the Safety Data Sheets (SDSs) and the manufacturer's instructions for adhesives, coatings, cleaners, consumables, coolants, degreasers, fluxes, and metals.

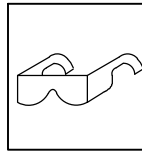

### FLYING METAL or DIRT can injure eyes.

- Welding, chipping, wire brushing, and grinding cause sparks and flying metal. As welds cool, they can throw off slag.
- Wear approved safety glasses with side shields even under your welding helmet.



### BUILDUP OF GAS can injure or kill.

- Shut off compressed gas supply when not in use.
- Always ventilate confined spaces or use approved air-supplied respirator.

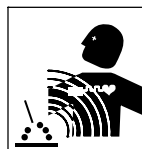

### ELECTRIC AND MAGNETIC FIELDS (EMF) can affect Implanted Medical Devices.

- Wearers of Pacemakers and other Implanted Medical Devices should keep away.
- Implanted Medical Device wearers should consult their doctor and the device manufacturer before going near arc welding, spot welding, gouging, plasma arc cutting, or induction heating operations.

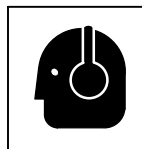

### NOISE can damage hearing.

Noise from some processes or equipment can damage hearing.

- Wear approved ear protection if noise level is high.



### CYLINDERS can explode if damaged.

Compressed gas cylinders contain gas under high pressure. If damaged, a cylinder can explode. Since gas cylinders are normally part of the welding process, be sure to treat them carefully.

- Protect compressed gas cylinders from excessive heat, mechanical shocks, physical damage, slag, open flames, sparks, and arcs.
- Install cylinders in an upright position by securing to a stationary support or cylinder rack to prevent falling or tipping.
- Keep cylinders away from any welding or other electrical circuits.
- Never drape a welding torch over a gas cylinder.
- Never allow a welding electrode to touch any cylinder.

- Never weld on a pressurized cylinder – explosion will result.
- Use only correct compressed gas cylinders, regulators, hoses, and fittings designed for the specific application; maintain them and associated parts in good condition.
- Turn face away from valve outlet when opening cylinder valve. Do not stand in front of or behind the regulator when opening the valve.
- Keep protective cap in place over valve except when cylinder is in use or connected for use.
- Use the proper equipment, correct procedures, and sufficient number of persons to lift, move, and transport cylinders.
- Read and follow instructions on compressed gas cylinders, associated equipment, and Compressed Gas Association (CGA) publication P-1 listed in Safety Standards.

## 1-3. Additional Symbols For Installation, Operation, And Maintenance



### FIRE OR EXPLOSION hazard.

- Do not install or place unit on, over, or near combustible surfaces.
- Do not install unit near flammables.
- Do not overload building wiring – be sure power supply system is properly sized, rated, and protected to handle this unit.



### FALLING EQUIPMENT can injure.

- Use lifting eye to lift unit only, NOT running gear, gas cylinders, or any other accessories.
- Use correct procedures and equipment of adequate capacity to lift and support unit.
- If using lift forks to move unit, be sure forks are long enough to extend beyond opposite side of unit.
- Keep equipment (cables and cords) away from moving vehicles when working from an aerial location.
- Follow the guidelines in the Applications Manual for the Revised NIOSH Lifting Equation (Publication No. 94-110) when manually lifting heavy parts or equipment.

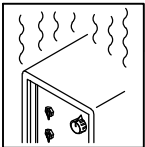

### OVERUSE can cause OVERHEATING

- Allow cooling period; follow rated duty cycle.
- Reduce current or reduce duty cycle before starting to weld again.
- Do not block or filter airflow to unit.

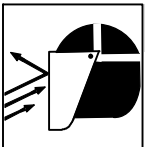

### FLYING SPARKS can injure.

- Wear a face shield to protect eyes and face.
- Shape tungsten electrode only on grinder with proper guards in a safe location wearing proper face, hand, and body protection.
- Sparks can cause fires — keep flammables away.

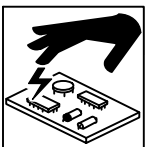

### STATIC (ESD) can damage PC boards.

- Put on grounded wrist strap BEFORE handling boards or parts.
- Use proper static-proof bags and boxes to store, move, or ship PC boards.

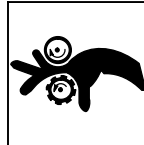

### MOVING PARTS can injure.

- Keep away from moving parts.
- Keep away from pinch points such as drive rolls.



### WELDING WIRE can injure.

- Do not press gun trigger until instructed to do so.
- Do not point gun toward any part of the body, other people, or any metal when threading welding wire.

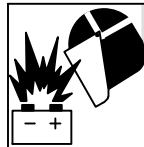

### BATTERY EXPLOSION can injure.

- Do not use welder to charge batteries or jump start vehicles unless it has a battery charging feature designed for this purpose.



### MOVING PARTS can injure.

- Keep away from moving parts such as fans.
- Keep all doors, panels, covers, and guards closed and securely in place.
- Have only qualified persons remove doors, panels, covers, or guards for maintenance and troubleshooting as necessary.
- Reinstall doors, panels, covers, or guards when maintenance is finished and before reconnecting input power.

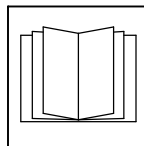

### READ INSTRUCTIONS.

- Read and follow all labels and the Owner's Manual carefully before installing, operating, or servicing unit. Read the safety information at the beginning of the manual and in each section.
- Use only genuine replacement parts from the manufacturer.
- Perform installation, maintenance, and service according to the Owner's Manuals, industry standards, and national, state, and local codes.

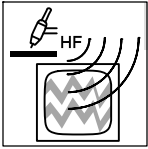

#### H.F. RADIATION can cause interference.

- High-frequency (H.F.) can interfere with radio navigation, safety services, computers, and communications equipment.

- Have only qualified persons familiar with electronic equipment perform this installation.
- The user is responsible for having a qualified electrician promptly correct any interference problem resulting from the installation.
- If notified by the FCC about interference, stop using the equipment at once.
- Have the installation regularly checked and maintained.
- Keep high-frequency source doors and panels tightly shut, keep spark gaps at correct setting, and use grounding and shielding to minimize the possibility of interference.

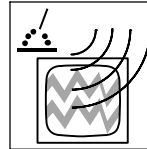

#### ARC WELDING can cause interference.

- Electromagnetic energy can interfere with sensitive electronic equipment such as computers and computer-driven equipment such as robots.

- Be sure all equipment in the welding area is electromagnetically compatible.
- To reduce possible interference, keep weld cables as short as possible, close together, and down low, such as on the floor.
- Locate welding operation 100 meters from any sensitive electronic equipment.
- Be sure this welding machine is installed and grounded according to this manual.
- If interference still occurs, the user must take extra measures such as moving the welding machine, using shielded cables, using line filters, or shielding the work area.

### 1-4. California Proposition 65 Warnings

**⚠ WARNING:** This product can expose you to chemicals including lead, which are known to the state of California to cause cancer and birth defects or other reproductive harm.

For more information, go to [www.P65Warnings.ca.gov](http://www.P65Warnings.ca.gov)

### 1-5. Principal Safety Standards

*Safety in Welding, Cutting, and Allied Processes*, ANSI Standard Z49.1, is available as a free download from the American Welding Society at <http://www.aws.org> or purchased from Global Engineering Documents (phone: 1-877-413-5184, website: [www.global.ihs.com](http://www.global.ihs.com)).

*Safe Practices for the Preparation of Containers and Piping for Welding and Cutting*, American Welding Society Standard AWS F4.1, from Global Engineering Documents (phone: 1-877-413-5184, website: [www.global.ihs.com](http://www.global.ihs.com)).

*Safe Practices for Welding and Cutting Containers that have Held Combustibles*, American Welding Society Standard AWS A6.0, from Global Engineering Documents (phone: 1-877-413-5184, website: [www.global.ihs.com](http://www.global.ihs.com)).

*National Electrical Code*, NFPA Standard 70, from National Fire Protection Association, Quincy, MA 02169 (phone: 1-800-344-3555, website: [www.nfpa.org](http://www.nfpa.org) and [www.sparky.org](http://www.sparky.org)).

*Safe Handling of Compressed Gases in Cylinders*, CGA Pamphlet P-1, from Compressed Gas Association, 14501 George Carter Way, Suite 103, Chantilly, VA 20151 (phone: 703-788-2700, website: [www.cganet.com](http://www.cganet.com)).

*Safety in Welding, Cutting, and Allied Processes*, CSA Standard W117.2, from Canadian Standards Association, Standards Sales, 5060 Spectrum Way, Suite 100, Mississauga, Ontario, Canada L4W 5N5 (phone: 800-463-6727, website: [www.csagroup.org](http://www.csagroup.org)).

*Safe Practice For Occupational And Educational Eye And Face Protection*, ANSI Standard Z87.1, from American National Standards Institute, 25 West 43rd Street, New York, NY 10036 (phone: 212-642-4900, website: [www.ansi.org](http://www.ansi.org)).

*Standard for Fire Prevention During Welding, Cutting, and Other Hot Work*, NFPA Standard 51B, from National Fire Protection Association, Quincy, MA 02169 (phone: 1-800-344-3555, website: [www.nfpa.org](http://www.nfpa.org)).

OSHA, Occupational Safety and Health Standards for General Industry, Title 29, Code of Federal Regulations (CFR), Part 1910.177 Subpart N, Part 1910 Subpart Q, and Part 1926, Subpart J, from U.S. Government Printing Office, Superintendent of Documents, P.O. Box 371954, Pittsburgh, PA 15250-7954 (phone: 1-866-512-1800) (there are 10 OSHA Regional Offices—phone for Region 5, Chicago, is 312-353-2220, website: [www.osha.gov](http://www.osha.gov)).

*Applications Manual for the Revised NIOSH Lifting Equation*, The National Institute for Occupational Safety and Health (NIOSH), 1600 Clifton Rd, Atlanta, GA 30329-4027 (phone: 1-800-232-4636, website: [www.cdc.gov/NIOSH](http://www.cdc.gov/NIOSH)).

### 1-6. EMF Information

Electric current flowing through any conductor causes localized electric and magnetic fields (EMF). The current from arc welding (and allied processes including spot welding, gouging, plasma arc cutting, and induction heating operations) creates an EMF field around the welding circuit. EMF fields can interfere with some medical implants, e.g. pacemakers. Protective measures for persons wearing medical implants have to be taken. For example, restrict access for passers-by or conduct individual risk assessment for welders. All welders should use the following procedures in order to minimize exposure to EMF fields from the welding circuit:

1. Keep cables close together by twisting or taping them, or using a cable cover.
2. Do not place your body between welding cables. Arrange cables to one side and away from the operator.
3. Do not coil or drape cables around your body.

4. Keep head and trunk as far away from the equipment in the welding circuit as possible.
5. Connect work clamp to workpiece as close to the weld as possible.
6. Do not work next to, sit or lean on the welding power source.
7. Do not weld whilst carrying the welding power source or wire feeder.

#### About Implanted Medical Devices:

Implanted Medical Device wearers should consult their doctor and the device manufacturer before performing or going near arc welding, spot welding, gouging, plasma arc cutting, or induction heating operations. If cleared by your doctor, then following the above procedures is recommended.



# SECTION 2 – CONSIGNES DE SÉCURITÉ – LIRE AVANT UTILISATION

som\_2018-01\_fre

**⚠** Pour écarter les risques de blessure pour vous-même et pour autrui — lire, appliquer et ranger en lieu sûr ces consignes relatives aux précautions de sécurité et au mode opératoire.

## 2-1. Symboles utilisés



**DANGER!** – Indique une situation dangereuse qui si on l'évite pas peut donner la mort ou des blessures graves. Les dangers possibles sont montrés par les symboles joints ou sont expliqués dans le texte.



Indique une situation dangereuse qui si on l'évite pas peut donner la mort ou des blessures graves. Les dangers possibles sont montrés par les symboles joints ou sont expliqués dans le texte.

**AVIS** – Indique des déclarations pas en relation avec des blessures personnelles.

 Indique des instructions spécifiques.



Ce groupe de symboles veut dire Avertissement! Attention! DANGER DE CHOC ÉLECTRIQUE, PIÈCES EN MOUVEMENT, et PIÈCES CHAUDES. Consulter les symboles et les instructions ci-dessous y afférant pour les actions nécessaires afin d'éviter le danger.

## 2-2. Dangers relatifs au soudage à l'arc

**⚠** Les symboles représentés ci-dessous sont utilisés dans ce manuel pour attirer l'attention et identifier les dangers possibles. En présence de l'un de ces symboles, prendre garde et suivre les instructions afférentes pour éviter tout risque. Les instructions en matière de sécurité indiquées ci-dessous ne constituent qu'un sommaire des instructions de sécurité plus complètes fournies dans les normes de sécurité énumérées dans la Section 2-5. Lire et observer toutes les normes de sécurité.

**⚠** L'installation, l'utilisation, l'entretien et les réparations ne doivent être confiés qu'à des personnes qualifiées. Une personne qualifiée est définie comme celle qui, par la possession d'un diplôme reconnu, d'un certificat ou d'un statut professionnel, ou qui, par une connaissance, une formation et une expérience approfondies, a démontré avec succès sa capacité à résoudre les problèmes liés à la tâche, le travail ou le projet et a reçu une formation en sécurité afin de reconnaître et d'éviter les risques inhérents.

**⚠** Pendant le fonctionnement, maintenir à distance toutes les personnes, notamment les enfants de l'appareil.



### UNE DÉCHARGE ÉLECTRIQUE peut entraîner la mort.

Le contact d'organes électriques sous tension peut provoquer des accidents mortels ou des brûlures graves. Le circuit de l'électrode et de la pièce est sous tension lorsque le courant est délivré à la sortie. Le circuit d'alimentation et les circuits internes de la machine sont également sous tension lorsque l'alimentation est sur Marche. Dans le mode de soudage avec du fil, le fil, le dérouleur, le bloc de commande du rouleau et toutes les parties métalliques en contact avec le fil sont sous tension électrique. Un équipement installé ou mis à la terre de manière incorrecte ou impropre constitue un danger.

- Ne pas toucher aux pièces électriques sous tension.
- Porter des gants isolants et des vêtements de protection secs et sans trous.
- S'isoler de la pièce à couper et du sol en utilisant des housses ou des tapis assez grands afin d'éviter tout contact physique avec la pièce à couper ou le sol.
- Ne pas utiliser de sortie de soudage CA dans des zones humides ou confinées ou s'il y a un risque de chute.
- Se servir d'une source électrique à courant électrique UNIQUEMENT si le procédé de soudage le demande.
- Si l'utilisation d'une source électrique à courant électrique s'avère nécessaire, se servir de la fonction de télécommande si l'appareil en est équipé.
- D'autres consignes de sécurité sont nécessaires dans les conditions suivantes : risques électriques dans un environnement humide ou si l'on porte des vêtements mouillés ; sur des structures métalliques telles que sols, grilles ou échafaudages ; en position coincée comme assise, à genoux ou couchée ; ou s'il y a un risque élevé de contact inévitable ou accidentel avec la pièce à souder ou le sol. Dans ces conditions, utiliser les équipements suivants, dans l'ordre indiqué : 1) un poste à souder DC à tension constante (à fil), 2) un poste à souder DC manuel (électrode) ou 3) un poste à souder AC à tension à vide réduite. Dans la plupart des situations,

l'utilisation d'un poste à souder DC à fil à tension constante est recommandée. En outre, ne pas travailler seul !

- Couper l'alimentation ou arrêter le moteur avant de procéder à l'installation, à la réparation ou à l'entretien de l'appareil. Déverrouiller l'alimentation selon la norme OSHA 29 CFR 1910.147 (voir normes de sécurité).
- Installez, mettez à la terre et utilisez correctement cet équipement conformément à son Manuel d'Utilisation et aux réglementations nationales, gouvernementales et locales.
- Toujours vérifier la terre du cordon d'alimentation. Vérifier et s'assurer que le fil de terre du cordon d'alimentation est bien raccordé à la borne de terre du sectionneur ou que la fiche du cordon est raccordée à une prise correctement mise à la terre.
- En effectuant les raccordements d'entrée, fixer d'abord le conducteur de mise à la terre approprié et contre-vérifier les connexions.
- Les câbles doivent être exempts d'humidité, d'huile et de graisse; protégez-les contre les étincelles et les pièces métalliques chaudes.
- Vérifier fréquemment le cordon d'alimentation et le conducteur de mise à la terre afin de s'assurer qu'il n'est pas altéré ou dénudé –, le remplacer immédiatement s'il l'est –. Un fil dénudé peut entraîner la mort.
- L'équipement doit être hors tension lorsqu'il n'est pas utilisé.
- Ne pas utiliser des câbles usés, endommagés, de grosseur insuffisante ou mal épissés.
- Ne pas enrouler les câbles autour du corps.
- Si la pièce soudée doit être mise à la terre, le faire directement avec un câble distinct.
- Ne pas toucher l'électrode quand on est en contact avec la pièce, la terre ou une électrode provenant d'une autre machine.
- Ne pas toucher des porte électrodes connectés à deux machines en même temps à cause de la présence d'une tension à vide doublée.
- N'utiliser qu'un matériel en bon état. Réparer ou remplacer sur-le-champ les pièces endommagées. Entretien l'appareil conformément à ce manuel.
- Porter un hamais de sécurité si l'on doit travailler au-dessus du sol.
- S'assurer que tous les panneaux et couvercles sont correctement en place.
- Fixer le câble de retour de façon à obtenir un bon contact métal-métal avec la pièce à souder ou la table de travail, le plus près possible de la soudure.
- Isoler la pince de masse quand pas mis à la pièce pour éviter le contact avec tout objet métallique.
- Ne pas raccorder plus d'une électrode ou plus d'un câble de masse à une même borne de sortie de soudage. Débrancher le câble pour le procédé non utilisé.
- Utiliser une protection différentielle lors de l'utilisation d'un équipement auxiliaire dans des endroits humides ou mouillés.

### Il reste une TENSION DC NON NÉGLIGEABLE dans les sources de soudage onduleur UNE FOIS l'alimentation coupée.

- Éteignez l'unité, débranchez le courant électrique, et déchargez les condensateurs d'alimentation selon les instructions indiquées dans le manuel avant de toucher les pièces.



### LES PIÈCES CHAUDES peuvent provoquer des brûlures.

- Ne pas toucher à mains nues les parties chaudes.
- Prévoir une période de refroidissement avant de travailler à l'équipement.

- Ne pas toucher aux pièces chaudes, utiliser les outils recommandés et porter des gants de soudage et des vêtements épais pour éviter les brûlures.



### LES FUMÉES ET LES GAZ peuvent être dangereux.

Le soudage génère des fumées et des gaz. Leur inhalation peut être dangereux pour votre santé.

- Eloigner votre tête des fumées. Ne pas respirer les fumées.
- À l'intérieur, ventiler la zone et/ou utiliser une ventilation forcée au niveau de l'arc pour l'évacuation des fumées et des gaz de soudage. Pour déterminer la bonne ventilation, il est recommandé de procéder à un prélèvement pour la composition et la quantité de fumées et de gaz auxquelles est exposé le personnel.
- Si la ventilation est médiocre, porter un respirateur anti-vapeurs approuvé.
- Lire et comprendre les fiches de données de sécurité et les instructions du fabricant concernant les adhésifs, les revêtements, les nettoyants, les consommables, les produits de refroidissement, les dégraisseurs, les flux et les métaux.
- Travailler dans un espace fermé seulement s'il est bien ventilé ou en portant un respirateur à alimentation d'air. Demander toujours à un surveillant dûment formé de se tenir à proximité. Des fumées et des gaz de soudage peuvent déplacer l'air et abaisser le niveau d'oxygène provoquant des blessures ou des accidents mortels. S'assurer que l'air de respiration ne présente aucun danger.
- Ne pas souder dans des endroits situés à proximité d'opérations de dégraissage, de nettoyage ou de pulvérisation. La chaleur et les rayons de l'arc peuvent réagir en présence de vapeurs et former des gaz hautement toxiques et irritants.
- Ne pas souder des métaux munis d'un revêtement, tels que l'acier galvanisé, plaqué en plomb ou au cadmium à moins que le revêtement n'ait été enlevé dans la zone de soudure, que l'endroit soit bien ventilé, et en portant un respirateur à alimentation d'air. Les revêtements et tous les métaux renfermant ces éléments peuvent dégager des fumées toxiques en cas de soudage.



### LES RAYONS DE L'ARC peuvent provoquer des brûlures dans les yeux et sur la peau.

Le rayonnement de l'arc du procédé de soudage génère des rayons visibles et invisibles intenses (ultraviolets et infrarouges) susceptibles de provoquer des brûlures dans les yeux et sur la peau. Des étincelles sont projetées pendant le soudage.

- Porter un casque de soudage approuvé muni de verres filtrants approprié pour protéger visage et yeux pour protéger votre visage et vos yeux pendant le soudage ou pour regarder (voir ANSI Z49.1 et Z87.1 énuméré dans les normes de sécurité).
- Porter des lunettes de sécurité avec écrans latéraux même sous votre casque.
- Avoir recours à des écrans protecteurs ou à des rideaux pour protéger les autres contre les rayonnements les éblouissements et les étincelles ; prévenir toute personne sur les lieux de ne pas regarder l'arc.
- Porter un équipement de protection pour le corps fait d'un matériau résistant et ignifuge (cuir, coton robuste, laine). La protection du corps comporte des vêtements sans huile comme par ex. des gants de cuir, une chemise solide, des pantalons sans revers, des chaussures hautes et une casquette.

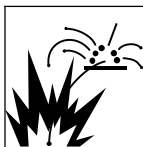

### LE SOUDAGE peut provoquer un incendie ou une explosion.

Le soudage effectué sur des conteneurs fermés tels que des réservoirs, tambours ou des conduites peut provoquer leur éclatement. Des étincelles peuvent être projetées de l'arc de soudure. La projection d'étincelles, des pièces chaudes et des équipements chauds peut provoquer des incendies et des brûlures. Le contact accidentel de l'électrode avec des objets métalliques peut provoquer des étincelles, une explosion, un surchauffement ou un incendie. Avant de commencer le soudage, vérifier et s'assurer que l'endroit ne présente pas de danger.

- Déplacer toutes les substances inflammables à une distance de 10,7 m de l'arc de soudage. En cas d'impossibilité les recouvrir soigneusement avec des protections homologués.
- Ne pas souder dans un endroit où des étincelles peuvent tomber sur des substances inflammables.
- Se protéger et d'autres personnes de la projection d'étincelles et de métal chaud.
- Des étincelles et des matériaux chauds du soudage peuvent facilement passer dans d'autres zones en traversant de petites fissures et des ouvertures.
- Surveiller tout déclenchement d'incendie et tenir un extincteur à proximité.
- Le soudage effectué sur un plafond, plancher, paroi ou séparation peut déclencher un incendie de l'autre côté.
- Ne pas couper ou souder des jantes ou des roues. Les pneus peuvent exploser s'ils sont chauffés. Les jantes et les roues réparées peuvent défaillir. Voir OSHA 29 CFR 1910.177 énuméré dans les normes de sécurité.
- Ne pas effectuer le soudage sur des conteneurs fermés tels que des réservoirs, tambours, ou conduites, à moins qu'ils n'aient été préparés correctement conformément à AWS F4.1 et AWS A6.0 (voir les Normes de Sécurité).
- Ne pas souder là où l'air ambiant pourrait contenir des poussières, gaz ou émanations inflammables (vapeur d'essence, par exemple).
- Brancher le câble de masse sur la pièce la plus près possible de la zone de soudage pour éviter le transport du courant sur une longue distance par des chemins inconnus éventuels en provoquant des risques d'électrocution, d'étincelles et d'incendie.
- Ne pas utiliser le poste de soudage pour dégeler des conduites gelées.
- En cas de non utilisation, enlever la baguette d'électrode du porte-électrode ou couper le fil à la pointe de contact.
- Porter un équipement de protection pour le corps fait d'un matériau résistant et ignifuge (cuir, coton robuste, laine). La protection du corps comporte des vêtements sans huile comme par ex. des gants de cuir, une chemise solide, des pantalons sans revers, des chaussures hautes et une casquette.
- Avant de souder, retirer toute substance combustible de vos poches telles qu'un allumeur au butane ou des allumettes.
- Une fois le travail achevé, assurez-vous qu'il ne reste aucune trace d'étincelles incandescentes ni de flammes.
- Utiliser exclusivement des fusibles ou coupe-circuits appropriés. Ne pas augmenter leur puissance; ne pas les ponter.
- Suivre les recommandations dans OSHA 1910.252(a)(2)(iv) et NFPA 51B pour les travaux à chaud et avoir de la surveillance et un extincteur à proximité.
- Lire et comprendre les fiches de données de sécurité et les instructions du fabricant concernant les adhésifs, les revêtements, les nettoyants, les consommables, les produits de refroidissement, les dégraisseurs, les flux et les métaux.

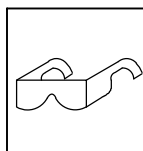

### DES PIÈCES DE METAL ou DES SALETES peuvent provoquer des blessures dans les yeux.

- Le soudage, l'écaillage, le passage de la pièce à la brosse en fil de fer, et le meulage génèrent des étincelles et des particules métalliques volantes. Pendant la période de refroidissement des soudures, elles risquent de projeter du laitier.
- Porter des lunettes de sécurité avec écrans latéraux ou un écran facial.



### LES ACCUMULATIONS DE GAZ risquent de provoquer des blessures ou même la mort.

- Fermer l'alimentation du gaz comprimé en cas de non utilisation.
- Veiller toujours à bien aérer les espaces confinés ou se servir d'un respirateur d'adduction d'air homologué.



### Les CHAMPS ÉLECTROMAGNÉTIQUES (CEM) peuvent affecter les implants médicaux.

- Les porteurs de stimulateurs cardiaques et autres implants médicaux doivent rester à distance.
- Les porteurs d'implants médicaux doivent consulter leur médecin et le fabricant du dispositif avant de s'approcher de la zone où se déroule du soudage à l'arc, du soudage par points, du gougeage, de la découpe plasma ou une opération de chauffage par induction.

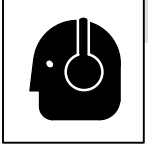

### LE BRUIT peut endommager l'ouïe.

Le bruit des processus et des équipements peut affecter l'ouïe.

- Porter des protections approuvées pour les oreilles si le niveau sonore est trop élevé.



### LES BOUTEILLES peuvent exploser si elles sont endommagées.

Les bouteilles de gaz comprimé contiennent du gaz sous haute pression. Si une bouteille est endommagée, elle peut exploser. Du fait que

les bouteilles de gaz font normalement partie du procédé de soudage, les manipuler avec précaution.

- Protéger les bouteilles de gaz comprimé d'une chaleur excessive, des chocs mécaniques, des dommages physiques, du laitier, des flammes ouvertes, des étincelles et des arcs.
- Placer les bouteilles debout en les fixant dans un support stationnaire ou dans un porte-bouteilles pour les empêcher de tomber ou de se renverser.
- Tenir les bouteilles éloignées des circuits de soudage ou autres circuits électriques.
- Ne jamais placer une torche de soudage sur une bouteille à gaz.
- Une électrode de soudage ne doit jamais entrer en contact avec une bouteille.
- Ne jamais souder une bouteille pressurisée – risque d'explosion.
- Utiliser seulement des bouteilles de gaz comprimé, régulateurs, tuyaux et raccords convenables pour cette application spécifique; les maintenir ainsi que les éléments associés en bon état.
- Tourner le dos à la sortie de vanne lors de l'ouverture de la vanne de la bouteille. Ne pas se tenir devant ou derrière le régulateur lors de l'ouverture de la vanne.
- Le couvercle du détendeur doit toujours être en place, sauf lorsque la bouteille est utilisée ou qu'elle est reliée pour usage ultérieur.
- Utilisez les équipements corrects, les bonnes procédures et suffisamment de personnes pour soulever, déplacer et transporter les bouteilles.
- Lire et suivre les instructions sur les bouteilles de gaz comprimé, l'équipement connexe et le dépliant P-1 de la CGA (Compressed Gas Association) mentionné dans les principales normes de sécurité.

## 2-3. Dangers supplémentaires en relation avec l'installation, le fonctionnement et la maintenance



### Risque D'INCENDIE OU D'EXPLOSION.

- Ne pas placer l'appareil sur, au-dessus ou à proximité de surfaces inflammables.
- Ne pas installer l'appareil à proximité de produits inflammables.
- Ne pas surcharger l'installation électrique – s'assurer que l'alimentation est correctement dimensionnée et protégée avant de mettre l'appareil en service.



### LA CHUTE DE L'ÉQUIPEMENT peut provoquer des blessures.

- Utiliser l'anneau de levage uniquement pour soulever l'appareil, NON PAS les chariots, les bouteilles de gaz ou tout autre accessoire.
- Utilisez les procédures correctes et des équipements d'une capacité appropriée pour soulever et supporter l'appareil.
- En utilisant des fourches de levage pour déplacer l'unité, s'assurer que les fourches sont suffisamment longues pour dépasser du côté opposé de l'appareil.
- Tenir l'équipement (câbles et cordons) à distance des véhicules mobiles lors de toute opération en hauteur.
- Suivre les consignes du Manuel des applications pour l'équation de levage NIOSH révisée (Publication N°94-110) lors du levage manuel de pièces ou équipements lourds.

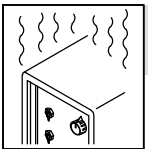

### L'EMPLOI EXCESSIF peut SURCHAUFFER L'ÉQUIPEMENT.

- Prévoir une période de refroidissement ; respecter le cycle opératoire nominal.
- Réduire le courant ou le facteur de marche avant de poursuivre le soudage.
- Ne pas obstruer les passages d'air du poste.

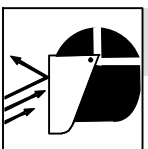

### LES ÉTINCELLES PROJÉTÉES peuvent provoquer des blessures.

- Porter un écran facial pour protéger le visage et les yeux.
- Affûter l'électrode au tungstène uniquement à la meuleuse dotée de protecteurs. Cette manœuvre est à exécuter dans un endroit sûr lorsque l'on porte l'équipement homologué de protection du visage, des mains et du corps.
- Les étincelles risquent de causer un incendie – éloigner toute substance inflammable.

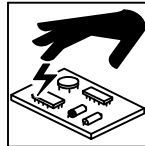

### LES CHARGES ÉLECTROSTATIQUES peuvent endommager les circuits imprimés.

- Établir la connexion avec la barrette de terre avant de manipuler des cartes ou des pièces.
- Utiliser des pochettes et des boîtes antistatiques pour stocker, déplacer ou expédier des cartes de circuits imprimés.

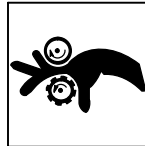

### Les PIÈCES MOBILES peuvent causer des blessures.

- Ne pas s'approcher des organes mobiles.
- Ne pas s'approcher des points de coincement tels que des rouleaux de commande.



### LES FILS DE SOUDAGE peuvent provoquer des blessures.

- Ne pas appuyer sur la gâchette avant d'en avoir reçu l'instruction.
- Ne pas diriger le pistolet vers soi, d'autres personnes ou toute pièce mécanique en engageant le fil de soudage.

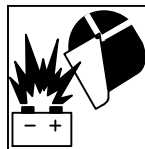

### L'EXPLOSION DE LA BATTERIE peut provoquer des blessures.

- Ne pas utiliser l'appareil de soudage pour charger des batteries ou faire démarrer des véhicules à l'aide de câbles de démarrage, sauf si l'appareil dispose d'une fonctionnalité de charge de batterie destinée à cet usage.



### Les PIÈCES MOBILES peuvent causer des blessures.

- S'abstenir de toucher des organes mobiles tels que des ventilateurs.
- Maintenir fermés et verrouillés les portes, panneaux, recouvrements et dispositifs de protection.
- Lorsque cela est nécessaire pour des travaux d'entretien et de dépannage, faire retirer les portes, panneaux, recouvrements ou dispositifs de protection uniquement par du personnel qualifié.
- Remettre les portes, panneaux, recouvrements ou dispositifs de protection quand l'entretien est terminé et avant de rebrancher l'alimentation électrique.

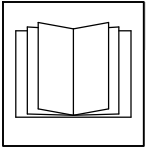

### LIRE LES INSTRUCTIONS.

- Lire et appliquer les instructions sur les étiquettes et le Mode d'emploi avant l'installation, l'utilisation ou l'entretien de l'appareil. Lire les informations de sécurité au début du manuel et dans chaque section.

- N'utiliser que les pièces de rechange recommandées par le constructeur.
- Effectuer l'installation, l'entretien et toute intervention selon les manuels d'utilisateurs, les normes nationales, provinciales et de l'industrie, ainsi que les codes municipaux.

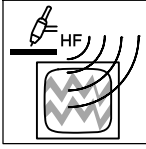

### LE RAYONNEMENT HAUTE FRÉQUENCE (H.F.) risque de provoquer des interférences.

- Le rayonnement haute fréquence (H.F.) peut provoquer des interférences avec les équipements de radio-navigation et de communication, les services de sécurité et les ordinateurs.
- Demander seulement à des personnes qualifiées familiarisées avec des équipements électroniques de faire fonctionner l'installation.
- L'utilisateur est tenu de faire corriger rapidement par un électricien qualifié les interférences résultant de l'installation.
- Si le FCC signale des interférences, arrêter immédiatement l'appareil.

- Effectuer régulièrement le contrôle et l'entretien de l'installation.
- Maintenir soigneusement fermés les portes et les panneaux des sources de haute fréquence, maintenir les éclateurs à une distance correcte et utiliser une terre et un blindage pour réduire les interférences éventuelles.



### LE SOUDAGE À L'ARC risque de provoquer des interférences.

- L'énergie électromagnétique risque de provoquer des interférences pour l'équipement électronique sensible tel que les ordinateurs et l'équipement commandé par ordinateur tel que les robots.
- Veiller à ce que tout l'équipement de la zone de soudage soit compatible électromagnétiquement.
- Pour réduire la possibilité d'interférence, maintenir les câbles de soudage aussi courts que possible, les grouper, et les poser aussi bas que possible (ex. par terre).
- Veiller à souder à une distance de 100 mètres de tout équipement électronique sensible.
- Veiller à ce que ce poste de soudage soit posé et mis à la terre conformément à ce mode d'emploi.
- En cas d'interférences après avoir pris les mesures précédentes, il incombe à l'utilisateur de prendre des mesures supplémentaires telles que le déplacement du poste, l'utilisation de câbles blindés, l'utilisation de filtres de ligne ou la pose de protecteurs dans la zone de travail.

## 2-4. Proposition californienne 65 Avertissements

**⚠ AVERTISSEMENT : ce produit peut vous exposer à des produits chimiques tels que le plomb, reconnus par l'État de Californie comme cancérigènes et sources de malformations ou d'autres troubles de la reproduction.**

Pour plus d'informations, consulter [www.P65Warnings.ca.gov](http://www.P65Warnings.ca.gov)

## 2-5. Principales normes de sécurité

*Safety in Welding, Cutting, and Allied Processes*, ANSI Standard Z49.1, is available as a free download from the American Welding Society at <http://www.aws.org> or purchased from Global Engineering Documents (phone: 1-877-413-5184, website: [www.global.ihs.com](http://www.global.ihs.com)).

*Safe Practices for the Preparation of Containers and Piping for Welding and Cutting*, American Welding Society Standard AWS F4.1, from Global Engineering Documents (phone: 1-877-413-5184, website: [www.global.ihs.com](http://www.global.ihs.com)).

*Safe Practices for Welding and Cutting Containers that have Held Combustibles*, American Welding Society Standard AWS A6.0, from Global Engineering Documents (phone: 1-877-413-5184, website: [www.global.ihs.com](http://www.global.ihs.com)).

*National Electrical Code*, NFPA Standard 70, from National Fire Protection Association, Quincy, MA 02169 (phone: 1-800-344-3555, website: [www.nfpa.org](http://www.nfpa.org) and [www.sparky.org](http://www.sparky.org)).

*Safe Handling of Compressed Gases in Cylinders*, CGA Pamphlet P-1, from Compressed Gas Association, 14501 George Carter Way, Suite 103, Chantilly, VA 20151 (phone: 703-788-2700, website: [www.cganet.com](http://www.cganet.com)).

*Safety in Welding, Cutting, and Allied Processes*, CSA Standard W117.2, from Canadian Standards Association, Standards Sales, 5060 Spec-

trum Way, Suite 100, Mississauga, Ontario, Canada L4W 5N5 (phone: 800-463-6727, website: [www.csagroup.org](http://www.csagroup.org)).

*Safe Practice For Occupational And Educational Eye And Face Protection*, ANSI Standard Z87.1, from American National Standards Institute, 25 West 43rd Street, New York, NY 10036 (phone: 212-642-4900, website: [www.ansi.org](http://www.ansi.org)).

*Standard for Fire Prevention During Welding, Cutting, and Other Hot Work*, NFPA Standard 51B, from National Fire Protection Association, Quincy, MA 02169 (phone: 1-800-344-3555, website: [www.nfpa.org](http://www.nfpa.org)).

OSHA, Occupational Safety and Health Standards for General Industry, Title 29, Code of Federal Regulations (CFR), Part 1910.177 Subpart N, Part 1910 Subpart Q, and Part 1926, Subpart J, from U.S. Government Printing Office, Superintendent of Documents, P.O. Box 371954, Pittsburgh, PA 15250-7954 (phone: 1-866-512-1800) (there are 10 OSHA Regional Offices—phone for Region 5, Chicago, is 312-353-2220, website: [www.osha.gov](http://www.osha.gov)).

*Applications Manual for the Revised NIOSH Lifting Equation*, The National Institute for Occupational Safety and Health (NIOSH), 1600 Clifton Rd, Atlanta, GA 30329-4027 (phone: 1-800-232-4636, website: [www.cdc.gov/NIOSH](http://www.cdc.gov/NIOSH)).

## 2-6. Informations relatives aux CEM

Le courant électrique qui traverse tout conducteur génère des champs électromagnétiques (CEM) à certains endroits. Le courant issu d'un soudage à l'arc (et de procédés connexes, y compris le soudage par points, le gougeage, le découpage plasma et les opérations de chauffage par induction) crée un champ électromagnétique (CEM) autour du circuit de soudage. Les champs électromagnétiques produits peuvent causer interférence à certains implants médicaux, p. ex. les stimulateurs cardiaques. Des mesures de protection pour les porteurs d'implants médicaux doivent être prises: Limiter par exemple tout accès aux passants ou procéder à une évaluation des risques individuels pour les soudeurs. Tous les soudeurs doivent appliquer les procédures suivantes pour minimiser l'exposition aux CEM provenant du circuit de soudage:

1. Rassembler les câbles en les torsadant ou en les attachant avec du ruban adhésif ou avec une housse.
2. Ne pas se tenir au milieu des câbles de soudage. Disposer les

câbles d'un côté et à distance de l'opérateur.

3. Ne pas courber et ne pas entourer les câbles autour de votre corps.
4. Maintenir la tête et le torse aussi loin que possible du matériel du circuit de soudage.
5. Connecter la pince sur la pièce aussi près que possible de la soudure.
6. Ne pas travailler à proximité d'une source de soudage, ni s'asseoir ou se pencher dessus.
7. Ne pas souder tout en portant la source de soudage ou le dévidoir.





### En ce qui concerne les implants médicaux :





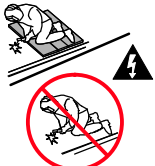
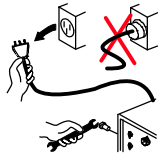

Les porteurs d'implants doivent d'abord consulter leur médecin avant de s'approcher des opérations de soudage à l'arc, de soudage par points, de gougeage, du coupage plasma ou de chauffage par induction. Si le médecin approuve, il est recommandé de suivre les procédures précédentes.

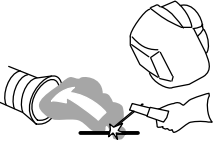
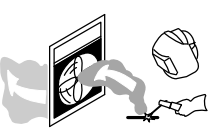
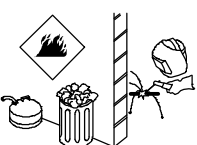
# SECTION 3 – DEFINITIONS

## 3-1. Additional Safety Symbols And Definitions

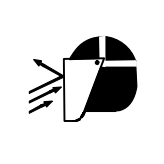
 Some symbols are found only on CE products.

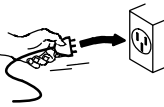
	<p>Warning! Watch Out! There are possible hazards as shown by the symbols.</p> <p style="text-align: right;">Safe1 2012-05</p>
	<p>Do not discard product (where applicable) with general waste. Reuse or recycle Waste Electrical and Electronic Equipment (WEEE) by disposing at a designated collection facility. Contact your local recycling office or your local distributor for further information.</p> <p style="text-align: right;">Safe37 2017-04</p>
	<p>Wear dry insulating gloves. Do not touch electrode with bare hand. Do not wear wet or damaged gloves.</p> <p style="text-align: right;">Safe2 2017-04</p>
	<p>Protect yourself from electric shock by insulating yourself from work and ground.</p> <p style="text-align: right;">Safe3 2017-04</p>
	<p>Disconnect input plug or power before working on machine.</p> <p style="text-align: right;">Safe5 2017-04</p>
	<p>Keep your head out of the fumes.</p> <p style="text-align: right;">Safe6 2017-04</p>
	<p>Use forced ventilation or local exhaust to remove the fumes.</p> <p style="text-align: right;">Safe8 2012-05</p>
	<p>Use ventilating fan to remove fumes.</p> <p style="text-align: right;">Safe10 2012-05</p>
	<p>Keep flammables away from welding. Do not weld near flammables.</p> <p style="text-align: right;">Safe12 2012-05</p>

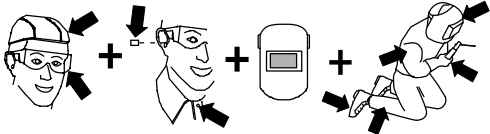
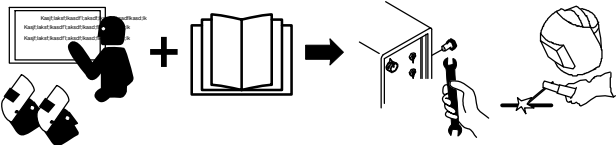
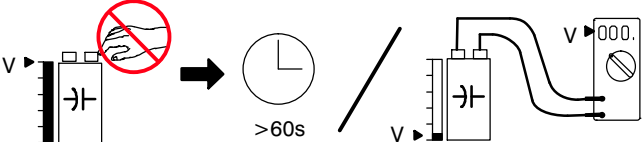
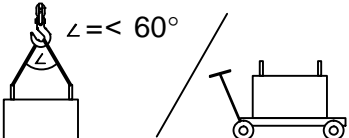
	<p>Welding sparks can cause fires. Have a fire extinguisher nearby, and have a watchperson ready to use it.</p> <p style="text-align: right;">Safe14 2012-05</p>
	<p>Do not weld on drums or any closed containers.</p> <p style="text-align: right;">Safe16 2017-04</p>
	<p>Do not remove or paint over (cover) the label.</p> <p style="text-align: right;">Safe20 2017-04</p>
	<p>Flying pieces of parts can cause injury. Always wear a face shield when servicing unit.</p> <p style="text-align: right;">Safe27 2012-05</p>
	<p>Always wear long sleeves and button your collar when servicing unit.</p> <p style="text-align: right;">Safe28 2012-05</p>
	<p>After taking proper precautions as shown, connect power to unit.</p> <p style="text-align: right;">Safe29 2012-05</p>
	<p>Do not use one handle to lift or support unit.</p> <p style="text-align: right;">Safe31 2017-04</p>
	<p>Wear hat and safety glasses. Use ear protection and button shirt collar. Use welding helmet with correct shade of filter. Wear complete body protection.</p> <p style="text-align: right;">Safe38 2012-05</p>
	<p>Become trained and read the instructions before working on the machine or welding.</p> <p style="text-align: right;">Safe40 2012-05</p>
	<p>Hazardous voltage remains on input capacitors after power is turned off. Do not touch fully charged capacitors. Always wait 60 seconds after power is turned off before working on unit, AND check input capacitor voltage, and be sure it is near 0 before touching any parts.</p> <p style="text-align: right;">Safe42 2017-04</p>
	<p>Always lift and support unit using both handles. Keep angle of lifting device less than 60 degrees.</p> <p>Use a proper cart to move unit.</p> <p style="text-align: right;">Safe44 2012-05</p>



# SECTION 4 – SPECIFICATIONS

## 4-1. Features And Benefits

**LVC™ Line Voltage Compensation** is circuitry that keeps the power source output constant regardless of input power fluctuation.

**Wind Tunnel Technology™** circulates air over components that require cooling, not over electronic circuitry, which reduces contaminants and improves reliability in harsh welding environments.

**Fan-On-Demand™** cooling system operates only when needed, reducing noise, energy use and the amount of contaminants pulled through the machine.

**Thermal Overload Protection** automatically shuts down the unit, only when necessary to prevent damage to internal components if the duty cycle is exceeded or air flow and cooling are restricted (see Section 4-7).

**Auto Remote Sense** enables the unit to automatically sense the connection of a remote control. Operation of the remote control is dependent on the Mode Switch Setting (see Section 6-2).

**Lift-Arc™** TIG starts provide a contamination free weld without the use of high frequency in the Lift-Arc TIG Welding Mode (see Section 7-3).

**ArcReach® Remote Control** allows remote control of various functions of the power source by an ArcReach compatible wire feeder or remote control device, without the use of a control cable (see Section 6-3). Operation of the ArcReach feature is dependent on the Mode Switch Setting (See section pertaining to process being used).

**Auto-Line™ Circuitry** automatically adapts to primary voltage (208 to 575 VAC) without having to relink the power source.

**Low OCV Operation** This unit can be configured to provide low Open Circuit Voltage (OCV) (see Section 9-4).

**Cable Length Compensation** will compensate for voltage drop in the weld cables by automatically adjusting the voltage at the power source while using a compatible wire feeder. The operator only needs to preset the desired weld voltage at the feeder without manually compensating for weld cable length.

## 4-2. Arc Controls

**Arc Control in Stick Mode** allows the arc characteristics, soft versus stiff, to be changed for specific applications and electrodes in Stick Welding Mode (see Section 9-3).

**Arc Control in Wire Mode** influences the arc stiffness, bead width and appearance, and puddle fluidity in MIG and V-Sense Feeder Welding Modes (see Sections 8-2 and 8-4).

**Programmable Hot Start Time** allows the start amperage time to be changed for Stick Welding Modes. This helps eliminate electrode sticking during arc initiation. (see Section 9-3).

## 4-3. Serial Number And Rating Label Location

The serial number and rating information for this product is located on the rear panel. Use rating label to determine input power requirements and/or rated output. For future reference, write serial number in space provided on back cover of this manual.

## 4-4. Unit Specifications

☞ Do not use information in unit specifications table to determine electrical service requirements. See Sections 5-7 and 5-8 for information on connecting input power.

☞ This equipment will deliver rated output at an ambient air temperature up to 104°F ( 40°C).

Input Power	Rated Output	Voltage Range in CV Mode	Amperage Range in CC Mode	Max. Open-Circuit Voltage	RMS Amps Input at Rated Load Output, 60 Hz 3-Phase at NEMA Load Voltages and Class I Rating					KVA	KW
					208 V	230 V	400 V	460 V	575 V		
3-Phase	350 A at 34 VDC, 60% Duty Cycle	10–38 V	5–425 A	75 VDC	40.4	36.1	20.6	17.8	14.1	14.2	13.6
1-Phase	300 A at 32 VDC, 60% Duty Cycle*				60.8	54.6	29.7	25.4	19.9		

\*See Section 4-7 for Duty Cycle Rating.



## 4-5. Dimensions And Weight

Hole Layout Dimensions	
A	12.875 in. (327 mm)
B	4.687 in. (119 mm)
C	15.75 in. (400 mm)
D	22.093 in. (561 mm)
E	8.687 in. (221 mm)
F	1.531 in. (39 mm)
G	1.687 in. (42 mm)
H	1/4-20 UNC -2B thread
<b>Weight</b>	
92 lb (41.7 kg)	

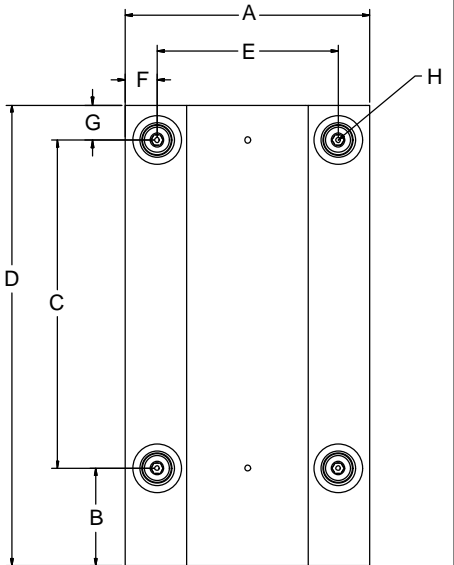

278579-A

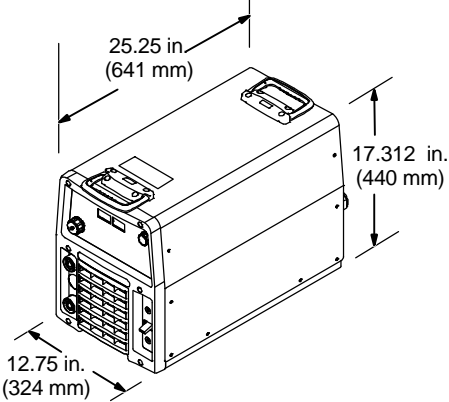

278673-A

## 4-6. Environmental Specifications

### A. IP Rating

<b>IP Rating</b>
IP23
This equipment is designed for outdoor use.
IP23 2017-02

### B. Temperature Specifications

Operating Temperature Range*	Storage/Transportation Temperature Range
14 to 104°F (-10 to 40°C)	-4 to 131°F (-20 to 55°C)
*Output is derated at temperatures above 104°F (40°C).	Temp_2016-07

## Notes

---

---

---

---

---

---

---

---

---

---

---

---

---

---

---

---

---

---

---

---

---

---

---

---

---

---



## 4-8. Volt-Ampere Curves

Volt-ampere curves show minimum and maximum voltage and amperage output capabilities of welding power source. Curves of other settings fall between curves shown.

### A. CC Mode

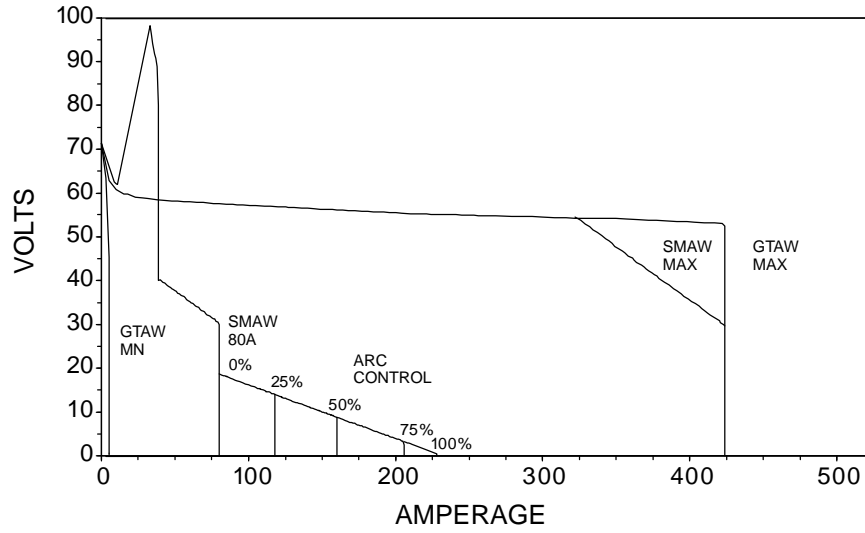

### B. CV Mode

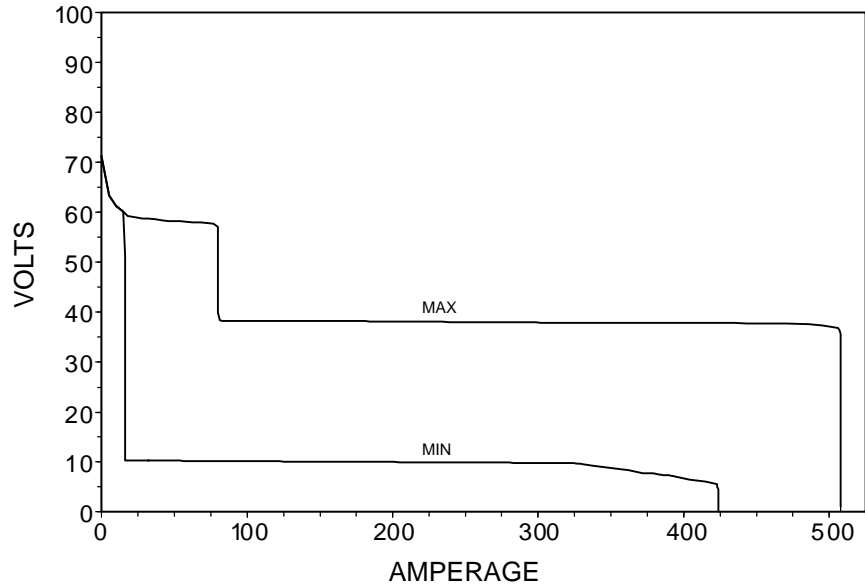

217 836-A / 217 837-B

## Notes

---



---



---



---



---



---



---



---



---



---



---



---

# SECTION 5 – INSTALLATION

## 5-1. Selecting A Location

--	--	--	--	--	--

**Movement**

**Do not move or operate unit where it could tip.**

**Location And Airflow**

**Special installation may be required where gasoline or volatile liquids are present – see NEC Article 511 or CEC Section 20.**

- 1 Lifting Forks  
Extend forks beyond opposite side of unit.
- 2 Lifting Handles  
Use handles to lift unit.
- 3 Hand Cart  
Use cart or similar device to move unit.
- 4 Line Disconnect Device  
Locate unit near correct input power supply.

loc\_med 2015-04

## Notes

---

---

---

---

---

---

---

---

---

---

---

---

---

---

---

---

---

---

---

---

---

---

---

---

## 5-2. Selecting Cable Sizes\*

**NOTICE** – The Total Cable Length in Weld Circuit (see table below) is the combined length of both weld cables. For example, if the power source is 100 ft (30 m) from the workpiece, the total cable length in the weld circuit is 200 ft (2 cables x 100 ft). Use the 200 ft (60 m) column to determine cable size.

Welding Amperes	Weld Cable Size** and Total Cable (Copper) Length in Weld Circuit Not Exceeding***							
	100 ft (30 m) or Less		150 ft (45 m)	200 ft (60 m)	250 ft (70 m)	300 ft (90 m)	350 ft (105 m)	400 ft (120 m)
	10 – 60% Duty Cycle AWG (mm <sup>2</sup> )	60 – 100% Duty Cycle AWG (mm <sup>2</sup> )	10 – 100% Duty Cycle AWG (mm <sup>2</sup> )					
100	4 (20)	4 (20)	4 (20)	3 (30)	2 (35)	1 (50)	1/0 (60)	1/0 (60)
150	3 (30)	3 (30)	2 (35)	1 (50)	1/0 (60)	2/0 (70)	3/0 (95)	3/0 (95)
200	3 (30)	2 (35)	1 (50)	1/0 (60)	2/0 (70)	3/0 (95)	4/0 (120)	4/0 (120)
250	2 (35)	1 (50)	1/0 (60)	2/0 (70)	3/0 (95)	4/0 (120)	2x2/0 (2x70)	2x2/0 (2x70)
300	1 (50)	1/0 (60)	2/0 (70)	3/0 (95)	4/0 (120)	2x2/0 (2x70)	2x3/0 (2x95)	2x3/0 (2x95)
350	1/0 (60)	2/0 (70)	3/0 (95)	4/0 (120)	2x2/0 (2x70)	2x3/0 (2x95)	2x3/0 (2x95)	2x4/0 (2x120)
400	1/0 (60)	2/0 (70)	3/0 (95)	4/0 (120)	2x2/0 (2x70)	2x3/0 (2x95)	2x4/0 (2x120)	2x4/0 (2x120)
500	2/0 (70)	3/0 (95)	4/0 (120)	2x2/0 (2x70)	2x3/0 (2x95)	2x4/0 (2x120)	3x3/0 (3x95)	3x3/0 (3x95)
600	3/0 (95)	4/0 (120)	2x2/0 (2x70)	2x3/0 (2x95)	2x4/0 (2x120)	3x3/0 (3x95)	3x4/0 (3x120)	3x4/0 (3x120)

\* This chart is a general guideline and may not suit all applications. If cable overheats, use next size larger cable.  
 \*\*Weld cable size (AWG) is based on either a 4 volts or less drop or a current density of at least 300 circular mils per ampere.  
 ( ) = mm<sup>2</sup> for metric use  
 \*\*\*For distances longer than those shown in this guide, see AWS Fact Sheet No. 39, Welding Cables, available from the American Welding Society at <http://www.aws.org>.

Ref. S-0007-M 2017-08

## 5-3. Weld Output Terminals

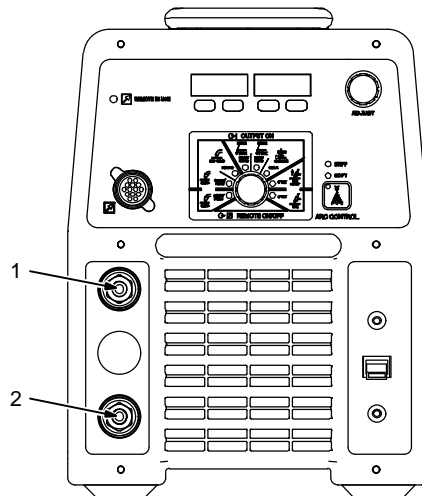



**⚠ Turn off power before connecting to weld output terminals.**

**⚠ Do not use worn, damaged, undersized, or repaired cables.**

- 1 Positive (+) Weld Output Terminal
- 2 Negative (-) Weld Output Terminal

📖 See Sections 7-1 thru 9-1 for standard connection diagrams.

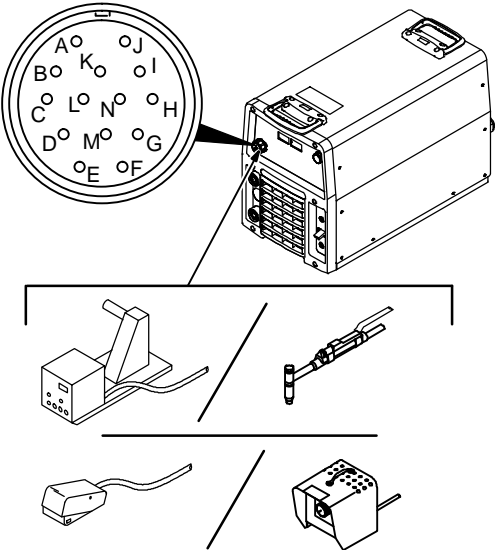
## 5-4. Remote 14 Receptacle Information

	 REMOTE 14	Socket*	Socket Information
<b>24 VOLTS AC OUTPUT (CONTACTOR)</b>		A	24 volts AC. Protected by supplementary protector or CB2.
		B	Contact closure to A completes 24 volts AC contactor control circuit.
<b>REMOTE OUTPUT CONTROL</b>		C	Output to remote control; 0 to +10 volts DC, +10 volts DC in MIG mode.
		D	Remote control circuit common.
		E	0 to +10 volts DC input command signal from remote control.
<b>A/V AMPLERAGE VOLTAGE</b>		F	Current feedback; +1 volt DC per 100 amperes.
		H	Voltage feedback; +1 volt DC per 10 output receptacle volts.
<b>GND</b>		G	Circuit common for 24 volts AC circuits.
		K	Chassis common.

\*The remaining sockets are not used.

## 5-5. Supplementary Protector

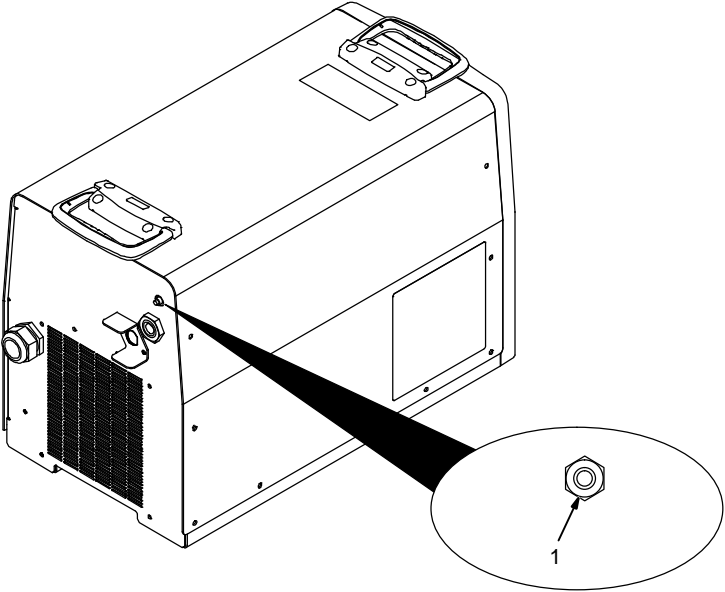

1 Supplementary Protector CB2  
CB2 protects 24 volts AC portion of Remote 14 receptacle from overload.

Press button to reset protector.

278673-A

## 5-6. Optional Gas Valve Operation And Shielding Gas Connection

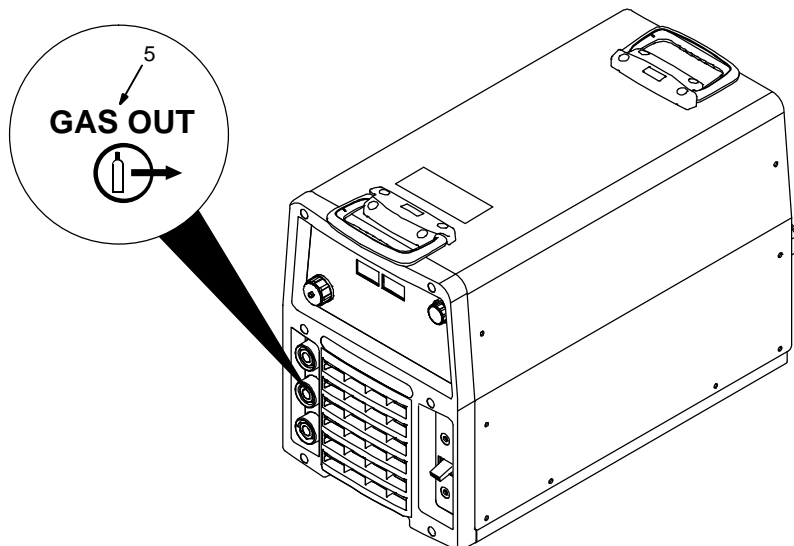
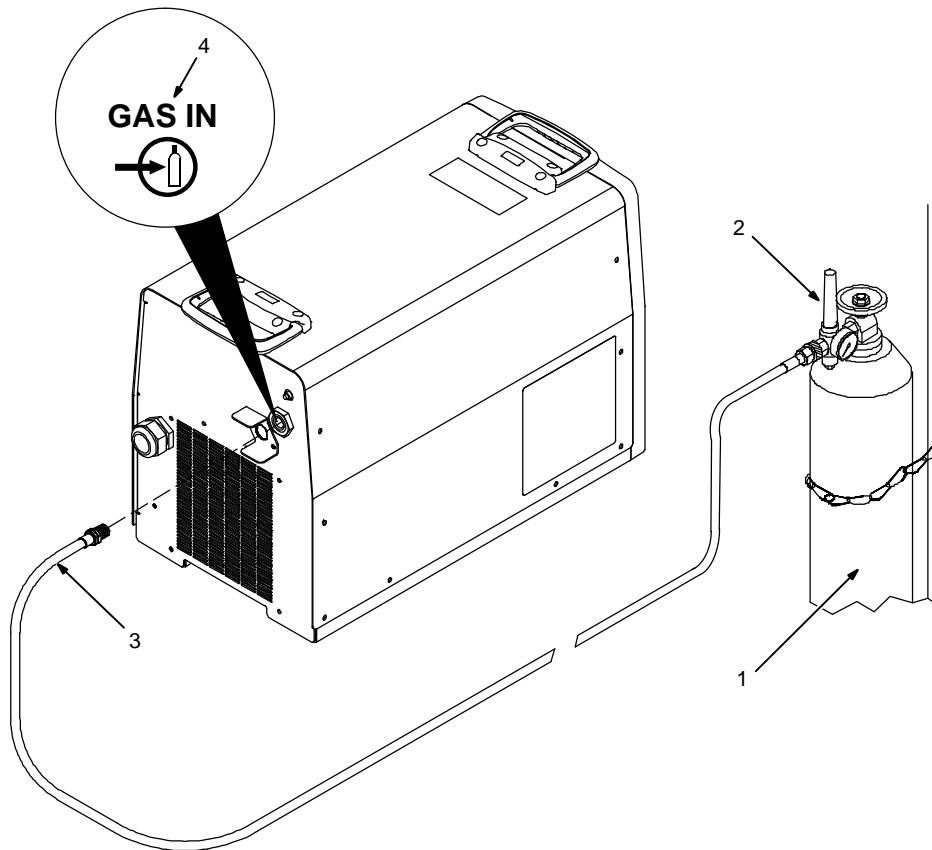

Obtain gas cylinder and chain to running gear, wall, or other stationary support so cylinder cannot fall and break off valve.

- 1 Cylinder
  - 2 Regulator/Flowmeter
- Install so face is vertical.
- 3 Gas Hose Connection

Fitting has 5/8-18 right-hand threads. Obtain and install gas hose.

- 4 Gas In Fitting
- 5 Gas Out Fitting

The Gas In and Gas Out fittings have 5/8-18 right-hand threads. Obtain proper size, type, and length hose and make connections as follows:

Connect hose from shielding gas supply regulator/flowmeter to Gas In fitting.

Connect hose coupler to torch. Connect one end of gas hose to hose coupler. Connect remaining end of gas hose to Gas Out fitting.

### Operation

The gas solenoid controls gas flow during the TIG process as follows:

#### Remote TIG

Gas flow starts with remote contactor on.

Gas flow stops at end of post-flow if current was detected, or with remote contactor off if no current was detected.

#### Lift-Arc TIG

Gas flow starts when tungsten touches work (touch sensed).

Gas flow stops at end of post-flow.

**Post-flow** time is factory set to 5 seconds per 100 amps of weld current. The minimum post-flow time is 5 seconds. The maximum post-flow is 20 seconds (post flow settings are not adjustable by the end user).

## 5-7. Electrical Service Guide

Elec Serv 2017-01

**NOTICE** – **INCORRECT INPUT POWER** can damage this welding power source. This welding power source requires a **CONTINUOUS** supply of input power at rated frequency ( $\pm 10\%$ ) and voltage ( $\pm 10\%$ ). Phase to ground voltage shall not exceed  $+10\%$  of rated input voltage. Do not use a generator with automatic idle device (that idles engine when no load is sensed) to supply input power to this welding power source.

**NOTICE** – Actual input voltage should not be 10% less than minimum and/or 10% more than maximum input voltages listed in table. If actual input voltage is outside this range, output may not be available.

**!** Failure to follow these electrical service guide recommendations could create an electric shock or fire hazard. These recommendations are for a dedicated circuit sized for the rated output and duty cycle of the welding power source.

In dedicated circuit installations, the National Electrical Code (NEC) allows the receptacle or conductor rating to be less than the rating of the circuit protection device. All components of the circuit must be physically compatible. See NEC articles 210.21, 630.11, and 630.12.

	60 Hz 1-Phase				
Input Voltage (V)	208	230	400	460	575
Rated Maximum Supply Current $I_{1max}$ (A)	60.1	53.5	29.3	25.2	19.7
Maximum Effective Supply Current $I_{1eff}$ (A)	38.0	33.8	18.6	15.9	12.5
Max Recommended Standard Fuse Rating In Amperes <sup>1</sup>					
Time-Delay Fuses <sup>2</sup>	70	60	35	30	25
Normal Operating Fuses <sup>3</sup>	80	80	45	40	30
Min Input Conductor Size In AWG (mm <sup>2</sup> ) <sup>4</sup>	8	8	10	12	12
Max Recommended Input Conductor Length In Feet (Meters)	72 (22)	89 (27)	176 (54)	140 (43)	219 (67)
Min Grounding Conductor Size In AWG (mm <sup>2</sup> ) <sup>4</sup>	8	8	10	12	12

	60 Hz 3-Phase				
Input Voltage (V)	208	230	400	460	575
Rated Maximum Supply Current $I_{1max}$ (A)	51.5	46.5	26.3	22.6	18
Maximum Effective Supply Current $I_{1eff}$ (A)	31.3	28.2	16	13.7	10.9
Max Recommended Standard Fuse Rating In Amperes <sup>1</sup>					
Time-Delay Fuses <sup>2</sup>	45	40	25	20	15
Normal Operating Fuses <sup>3</sup>	60	50	30	25	20
Min Input Conductor Size In AWG (mm <sup>2</sup> ) <sup>4</sup>	8	10	12	14	14
Max Recommended Input Conductor Length In Feet (Meters)	119 (36)	96 (29)	175 (53)	150 (46)	234 (71)
Min Grounding Conductor Size In AWG (mm <sup>2</sup> ) <sup>4</sup>	10	10	12	14	14

Reference: 2017 National Electrical Code (NEC) (including article 630)

1 If a circuit breaker is used in place of a fuse, choose a circuit breaker with time-current curves comparable to the recommended fuse.

2 "Time-Delay" fuses are UL class "RK5". See UL 248.

3 "Normal Operating" (general purpose - no intentional delay) fuses are UL class "K5" (up to and including 60 amps), and UL class "H" (65 amps and above).

4 Conductor data in this section specifies conductor size (excluding flexible cord or cable) between the panelboard and the equipment per NEC Table 310.15(B)(16) and is based on allowable ampacities of insulated copper conductors having a temperature rating of 167°F (75°C) with not more than three single current-carrying conductors in a raceway. If a flexible cord or cable is used, minimum conductor size may increase. See NEC Table 400.5(A) for flexible cord and cable requirements.





## 5-8. Connecting 1-Phase Input Power

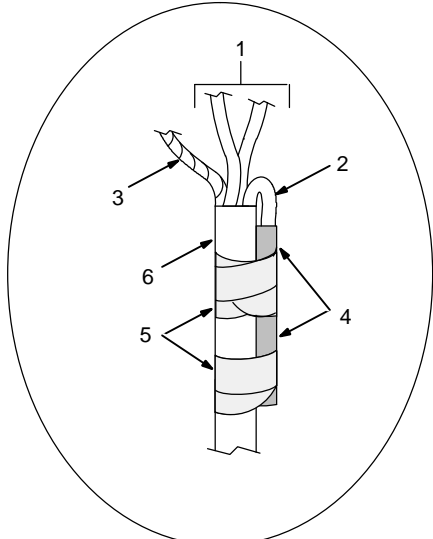
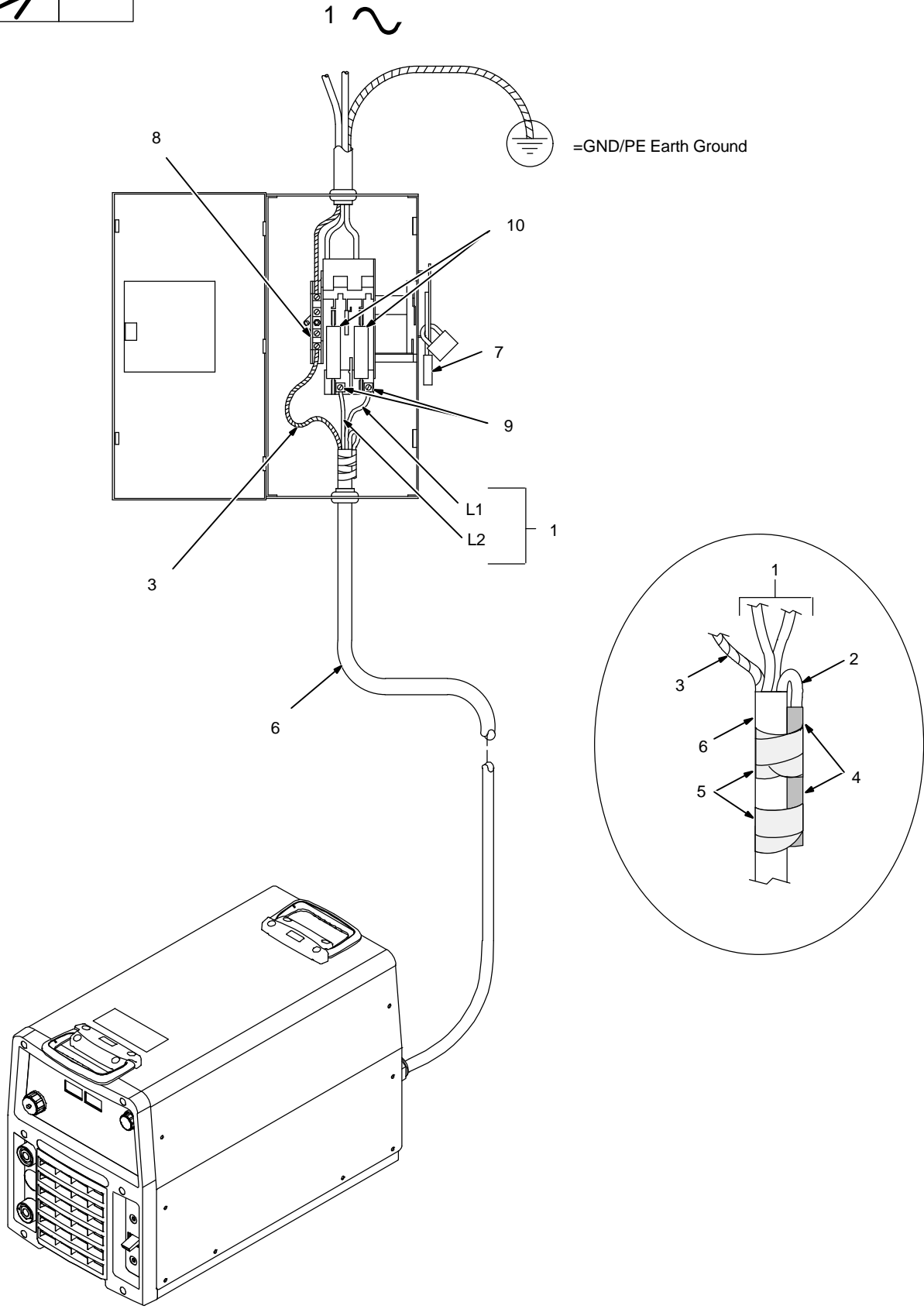

Tools Needed:

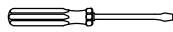

Input1 2012-05 - Ref. 803766-C / 278673-A

## 5-8. Connecting 1-Phase Input Power (Continued)



**⚠** Installation must meet all National and Local Codes – have only qualified persons make this installation.

**⚠** Disconnect and lockout/tagout input power before connecting input conductors from unit. Follow established procedures regarding the installation and removal of lockout/tagout devices.

**⚠** Always connect green or green/yellow conductor to supply grounding terminal first, and never to a line terminal.

**NOTICE** – The Auto-Line circuitry in this unit automatically adapts the power source to the primary voltage being applied. Check input voltage available at site. This unit can be con-

ected to any input power between 208 and 575 VAC without removing cover to relink the power source.

See rating label on unit and check input voltage available at site.

- 1 Black And White Input Conductor (L1 And L2)
- 2 Red Input Conductor
- 3 Green Or Green/Yellow Grounding Conductor
- 4 Insulation Sleeving
- 5 Electrical Tape
- 6 Input Power Cord.

Insulate and isolate red conductor as shown.

7 Disconnect Device (switch shown in the OFF position)

8 Disconnect Device Grounding Terminal

9 Disconnect Device Line Terminals

Connect green or green/yellow grounding conductor to disconnect device grounding terminal first.

Connect input conductors L1 and L2 to disconnect device line terminals.

10 Over-Current Protection

Select type and size of over-current protection using Section 5-7 (fused disconnect switch shown).

Close and secure door on disconnect device. Follow established lockout/tagout procedures to put unit in service.

Input1 2012-05

## Notes

---



---



---



---



---



---



---



---



---



---



---



---



---



---



---



---



---



---



---



---



---



---



**Work like a Pro!**

**Pros weld and cut safely. Read the safety rules at the beginning of this manual.**

## 5-9. Connecting 3-Phase Input Power

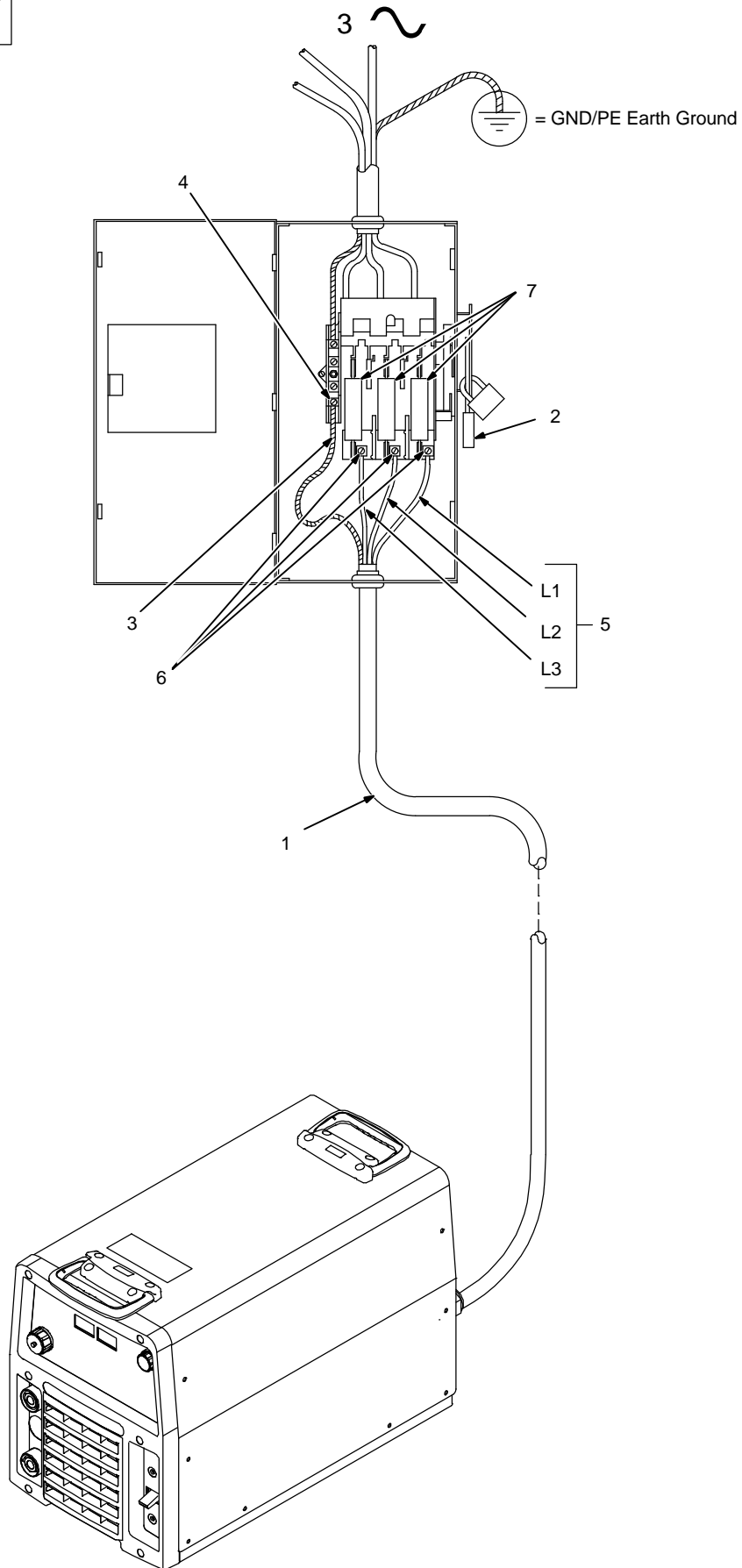

Tools Needed:

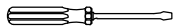

input2 2012-05 - Ref. 803766-C / 278673-A

## 5-9. Connecting 3-Phase Input Power (Continued)



**!** Installation must meet all National and Local Codes – have only qualified persons make this installation.

**!** Disconnect and lockout/tagout input power before connecting input conductors from unit. Follow established procedures regarding the installation and removal of lockout/tagout devices.

**!** Always connect green or green/yellow conductor to supply grounding terminal first, and never to a line terminal.

**NOTICE** – The Auto-Line circuitry in this unit automatically adapts the power source to the primary voltage being applied. Check input

voltage available at site. This unit can be connected to any input power between 208 and 575 VAC without removing cover to relink the power source.

See rating label on unit and check input voltage available at site.

### For Three-Phase Operation

- 1 Input Power Cord.
- 2 Disconnect Device (switch shown in the OFF position)
- 3 Green Or Green/Yellow Grounding Conductor
- 4 Disconnect Device Grounding Terminal

5 Input Conductors (L1, L2 And L3)

6 Disconnect Device Line Terminals

Connect green or green/yellow grounding conductor to disconnect device grounding terminal first.

Connect input conductors L1, L2, and L3 to disconnect device line terminals.

7 Over-Current Protection

Select type and size of over-current protection using Section 5-7 (fused disconnect switch shown).

Close and secure door on disconnect device. Follow established lockout/tagout procedures to put unit in service.

input2 2012-05

## Notes

---



---



---



---



---



---



---



---



---



---



---



---



**Work like a Pro!**

**Pros weld and cut safely. Read the safety rules at the beginning of this manual.**





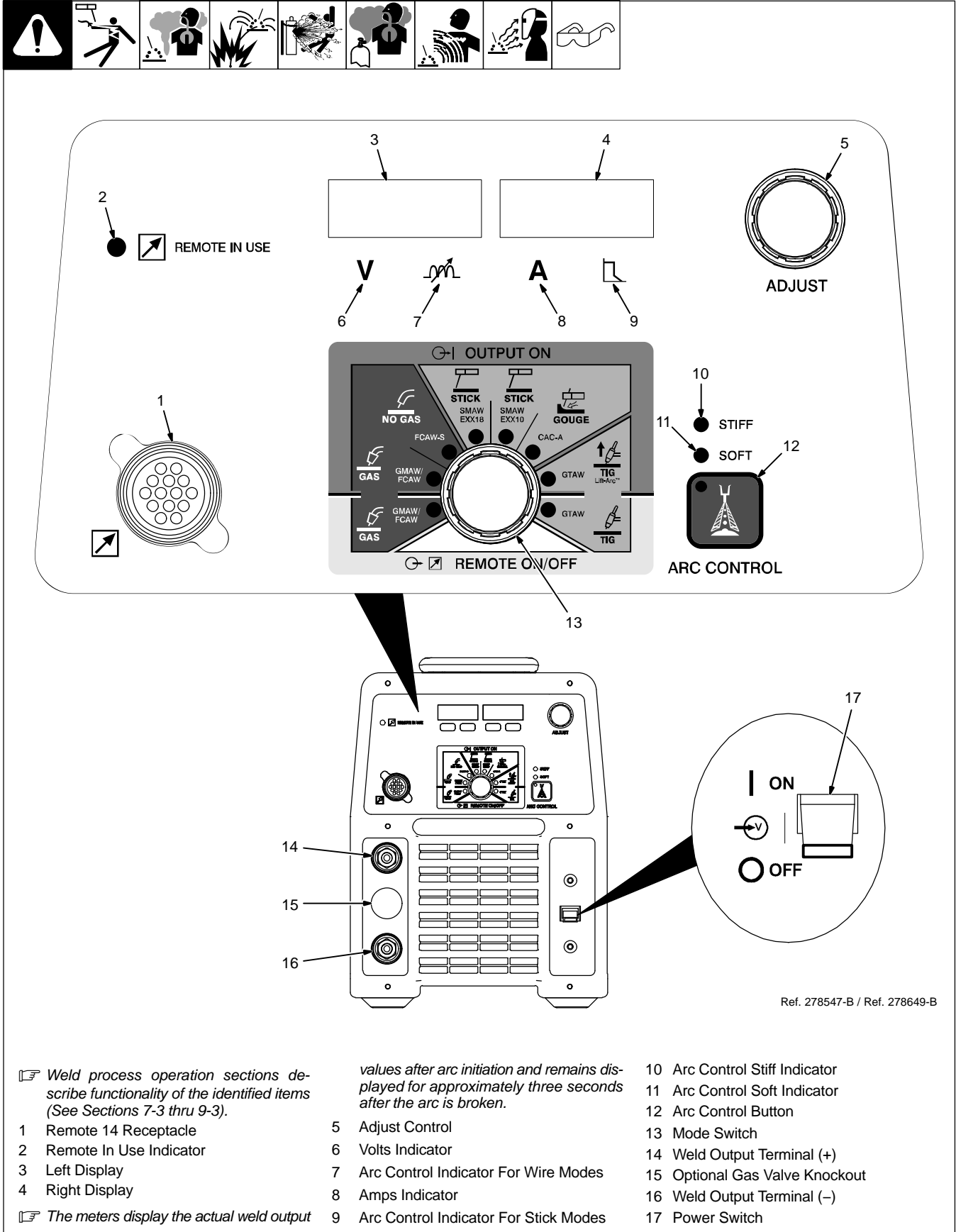



# SECTION 6 – OPERATION

## 6-1. Front Panel Controls



Ref. 278547-B / Ref. 278649-B

## 6-2. Mode Switch Settings

Switch Position		Process	Output Control	Panel Adjust	Remote 14 Adjust	ArcReach Adjust
	WIRE – Gas	GMAW FCAW	Remote 14	Volts	Volts	--
	WIRE – Gas (1)	GMAW FCAW	Electrode Hot	Volts	Volts	Volts
	WIRE - No Gas (1)	FCAW-S	Electrode Hot	Volts	Volts	Volts
	STICK EXX18 (1)	SMAW	Electrode Hot	Amps	% Panel Amps*	Amps
	STICK EXX10 (1)	SMAW	Electrode Hot	Amps	% Panel Amps*	Amps
	GOUGE (1)	CAC-A	Electrode Hot	Amps	% Panel Amps*	Amps
	Lift-Arc TIG (1)	GTAW	Electrode Hot	Amps	% Panel Amps	Amps
	TIG	GTAW	Remote 14	Amps	% Panel Amps	--

(1) An ArcReach device will override any control connected to remote 14-pin receptacle.  
\*See Section 9-5 Alternate Configuration Functions

## 6-3. Associating ArcReach Device To ArcReach Power Source

### Quick Setup Guide:

- 1 Make connections between power source and ArcReach device. (See section pertaining to mode being used for typical connection diagrams).
- 2 This power source has the ability to associate with an ArcReach device at power up, or when an ArcReach wire feeder is triggered. The Mode Switch on this power source must be set to an "OUTPUT ON" mode to associate with another ArcReach device.
- 3 See instructions in the owner's manual for the specific ArcReach device to associate the device to this power source.
- 4 During the association process the Remote in Use indicator will blink.
- 5 When the association process is complete, the Remote In Use indicator will be lit. Dependent on the capabilities of the ArcReach device; the mode switch, voltage/amperage adjustment, and Arc Control adjustment may be overridden by the ArcReach device.

## 6-4. Powering An ArcReach Smart Feeder In Lift-Arc TIG Mode

 To power an ArcReach Smart Feeder in Lift-Arc TIG mode, the OCV will need to be changed to 28.0.

### Procedure:

- 1 Turn mode switch to Lift-Arc TIG.
- 2 Hold Arc Control button in for 3 seconds until OCV 14.0 or OCV 28.0 is displayed.
- 3 Turn adjust knob to select OCV 28.0 for powering ArcReach Smart Feeder.
- 4 Once selected, OCV 28.0 will be the new default.
- 5 For normal Lift-Arc TIG operation follow the same procedure to select OCV 14.0.

# SECTION 7 – GTAW OPERATION

## 7-1. Typical Connection For GTAW Process

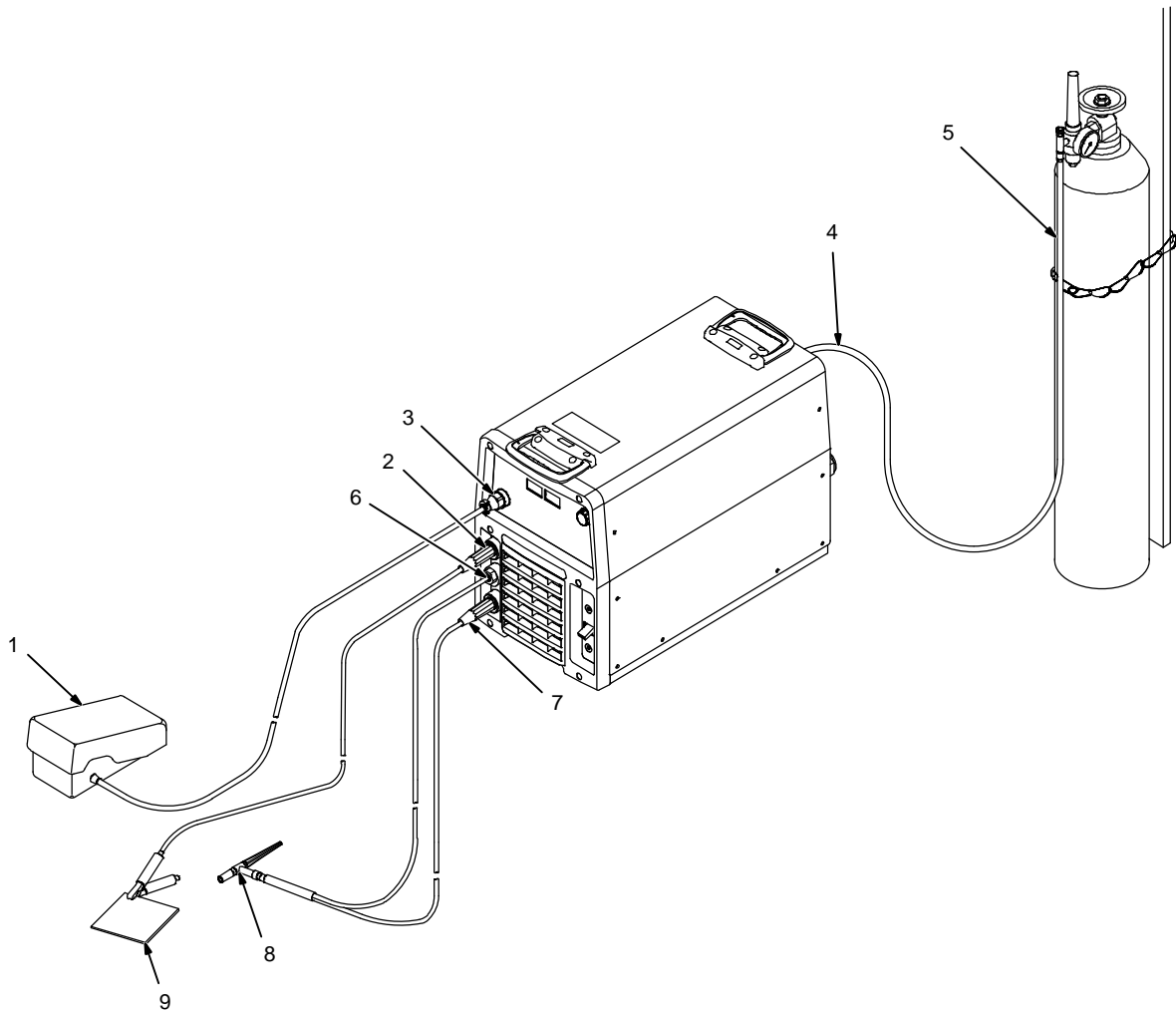
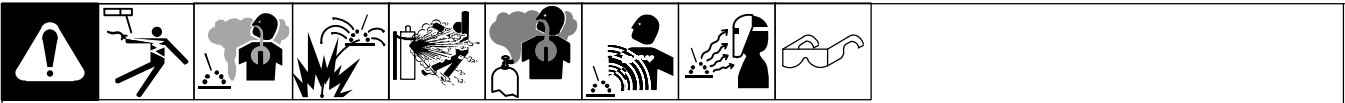

278669-A

**⚠ Turn off power before making connections.**

1 Foot Control

2 Positive (+) Weld Output Terminal

3 Remote 14 Receptacle

Connect desired remote control to Remote 14 receptacle if required.

4 Gas In Connection (Optional)

5 Gas Cylinder

6 Gas Out Connection (Optional)

7 Negative (-) Weld Output Terminal

8 TIG Torch

9 Workpiece



## 7-2. Typical Connection For ArcReach Stick/TIG Remote (GTAW Process)

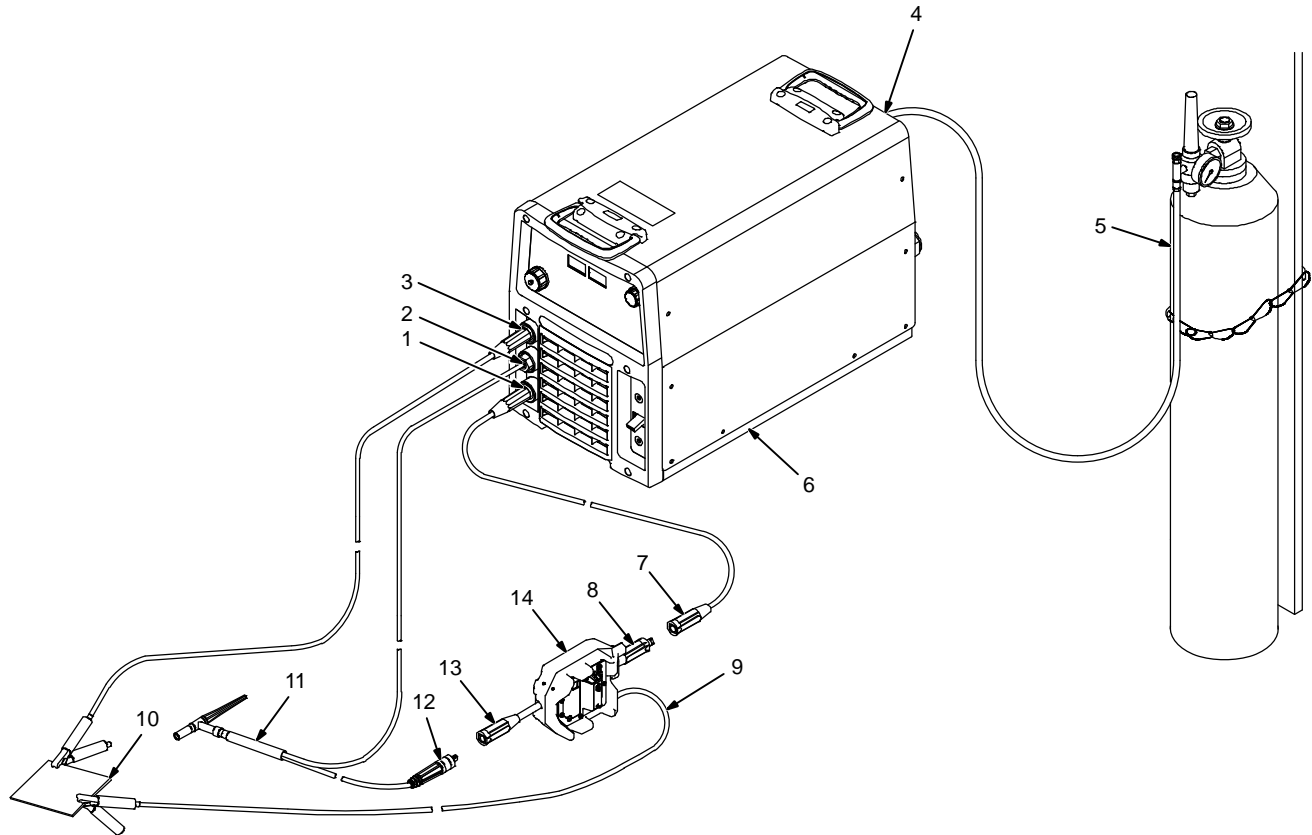
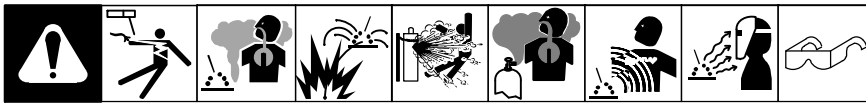

Ref. 280219-A

**⚠** Turn Off welding power source before making any input or output weld cable connections.

**⚠** Turn Off welding power source before handling or moving voltage sensing clamp. Weld voltage is present at voltage sensing clamp when welding power source is on. This condition exists even if Polarity Indicators and Amps/Arc Control Display on this remote are not lit.

☞ When the ArcReach Stick/TIG Remote is connected to the power source as electrode negative, the remote will set the welding power source to a TIG

mode. The electrode negative (TIG) indicator on the remote will be lit.

- 1 Negative (-) Weld Output Terminal  
Connection for weld cable going to remote.
- 2 Gas Out Connection (Optional)
- 3 Positive (+) Weld Output Terminal  
Connection for work cable going to workpiece.
- 4 Gas In Connection (Optional)
- 5 Gas Cylinder
- 6 Welding Power Source
- 7 Female Connector (User Supplied LC-40 Style Female Connector)
- 8 Input Weld Cable (With Supplied Male Connector)

- 9 Voltage Sensing Lead

Attach voltage sensing lead clamp to workpiece.

- 10 Workpiece
- 11 TIG Torch
- 12 Male Connector (User Supplied LC-40 Style Male Connector)
- 13 Output Weld Cable (With Supplied Female Connector)
- 14 ArcReach Stick/TIG Remote

☞ An additional weld cable may be used in parallel with the remote if weld current exceeds amperage rating of the remote.

## 7-3. Lift-Arc TIG Welding Mode - GTAW Lift-Arc - Output On

278547-B

**Weld terminals are energized at all times in Lift Arc TIG welding mode.**

**Setup**  
For typical system connections refer to Section 7-1.

**Operation**  
The Adjust Control is used to set desired preset amperage.

**Do NOT Strike Like A Match!**

**⚠** Weld terminals are energized at all times in Lift Arc TIG welding mode.

☞ An ArcReach Smart Feeder will not power up in normal Lift-Arc mode (See Section 6-4).

- 1 Mode Switch
- 2 Volts Indicator
- 3 Left Display
- 4 Right Display
- 5 Amps Indicator
- 6 Adjust Control
- 7 Workpiece
- 8 Tungsten Electrode
- 9 Remote 14 Receptacle
- 10 Remote In Use Indicator

### Setup

For typical system connections refer to Section 7-1.

Set Mode Switch to GTAW LIFT-ARC position.

ON is shown in the Left Display. Preset amperage is shown in the Right Display with the Amps Indicator lit.

Normal open-circuit voltage is not present before the electrode touches the workpiece, instead a low sensing voltage is present. The sensing voltage allows the electrode to touch the workpiece without overheating, sticking, or getting contaminated.

### Operation

The Adjust Control is used to set desired preset amperage.

☞ If a remote control is connected to the Remote14 Receptacle and used for amperage adjustment, the adjustment will function as a percentage of the preset amperage. The Remote In Use indicator will be lit.

☞ If an ArcReach device is used for amperage adjustment, it will have full range of the preset amperage. If the ArcReach device is capable of communication while welding, the amperage can be adjusted while welding. Dependent on the capabilities of the device, it may have the ability to override parameter adjustments and mode switch setting. The Remote In Use indicator will be lit. An ArcReach device will override a remote control connected to the Remote 14 Receptacle.

☞ For best results, firmly touch the tungsten electrode to the workpiece at the weld start point. Hold electrode to workpiece for 1-2 seconds, and lift electrode. An arc will form when the electrode is lifted. To minimize arc flare at the end of the weld, pull back the electrode quickly to extinguish the arc.

## 7-4. TIG Welding Mode - GTAW - Remote ON/OFF

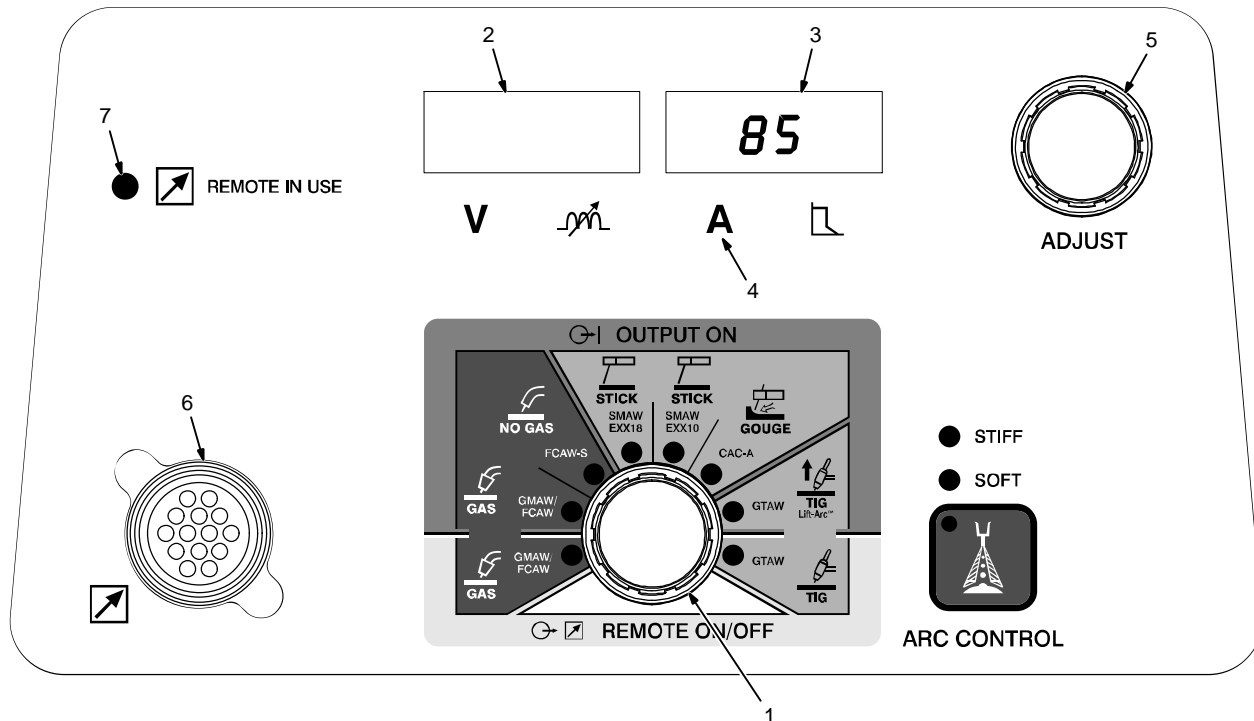
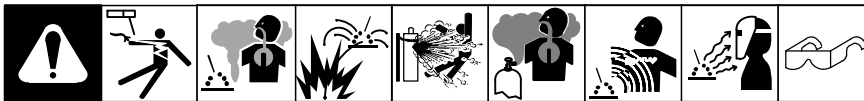

278547-B

**⚠** Weld terminals are energized through the remote control in TIG welding mode.

- 1 Mode Switch
- 2 Left Display
- 3 Right Display
- 4 Amps Indicator
- 5 Adjust Control
- 6 Remote 14 Receptacle
- 7 Remote In Use Indicator

### Setup

For typical system connections refer to Section 7-1.

Set Mode Switch to GTAW TIG position.

The preset amperage is shown in the Right Display with the Amps Indicator lit.

### Operation

The Adjust Control is used to set desired preset amperage.

A remote control is required to turn on the weld output.

**ℹ** If a remote control is connected to the Remote14 Receptacle and used for amperage adjustment, the adjustment will function as a percentage of the preset amperage. The Remote In Use indicator will be lit.

**ℹ** An ArcReach remote control is not compatible in this mode.

**ℹ** For best results, gently scratch the tungsten electrode to the work to initiate an arc. To minimize arc flare at the end of the weld, pull back the electrode quickly to extinguish the arc.

# SECTION 8 – GMAW/FCAW OPERATION

## 8-1. Typical Connection For Remote Control Feeder GMAW/FCAW Process

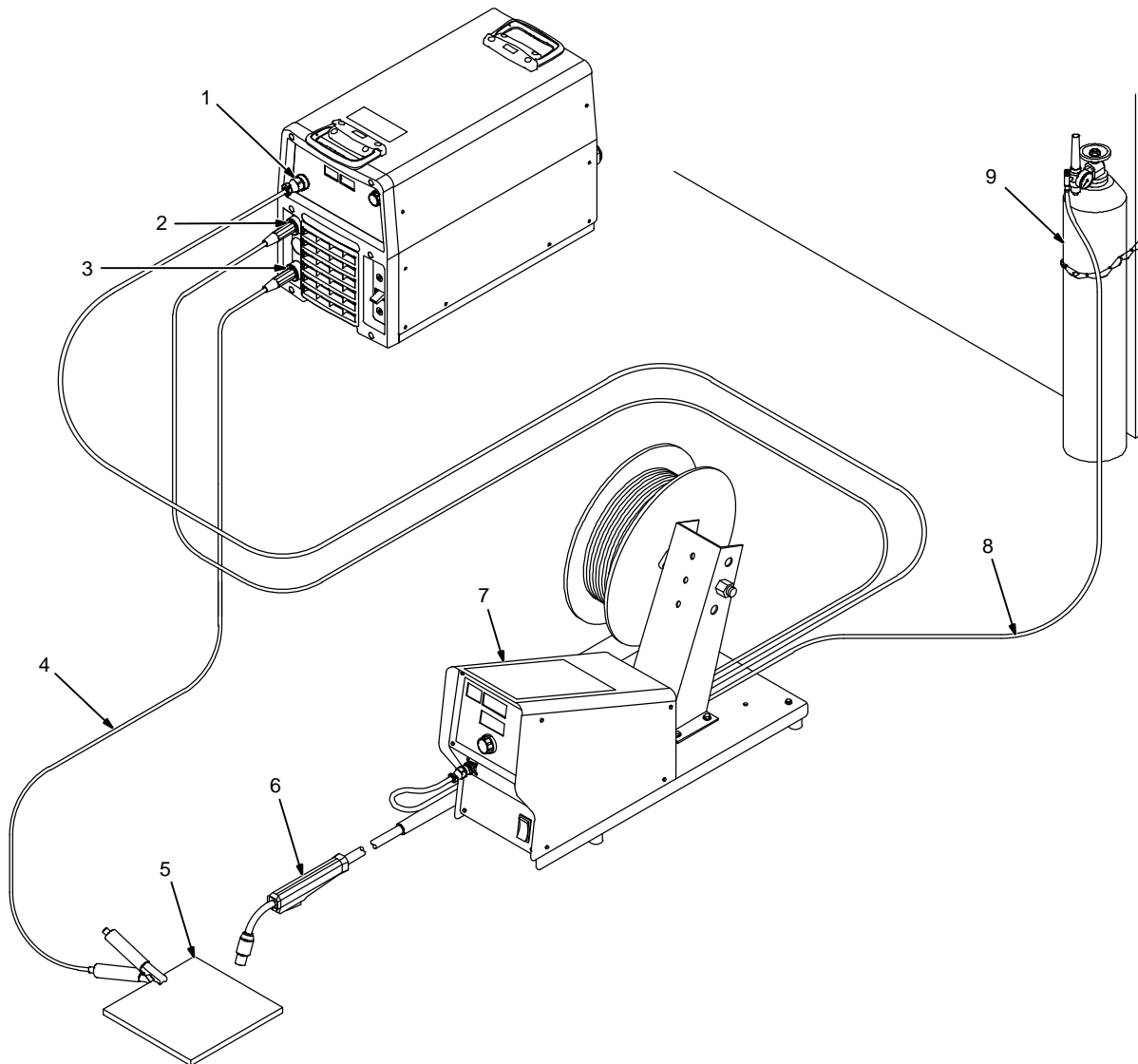
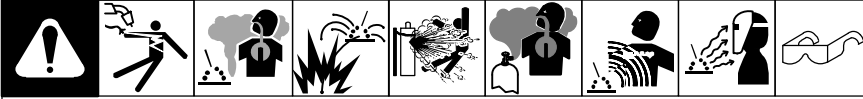

278670-A

**⚠ Turn off power before making connections.**

- 1 Remote 14-Receptacle
- 2 Positive (+) Weld Output Terminal
- 3 Negative (-) Weld Output Terminal
- 4 Ground Cable to Workpiece

- 5 Workpiece
- 6 Gun
- 7 Wire Feeder
- 8 Gas Hose
- 9 Gas Cylinder

Use of shielding gas is dependant on Wire Type.

**☞** The connection diagram illustrates DCEP (reverse polarity) suitable for all wires except self-shielded FCAW-S. The majority of self-shielded FCAW-S wires require DCEN (straight polarity).

## 8-2. MIG Welding Mode - GMAW/FCAW Remote ON/OFF

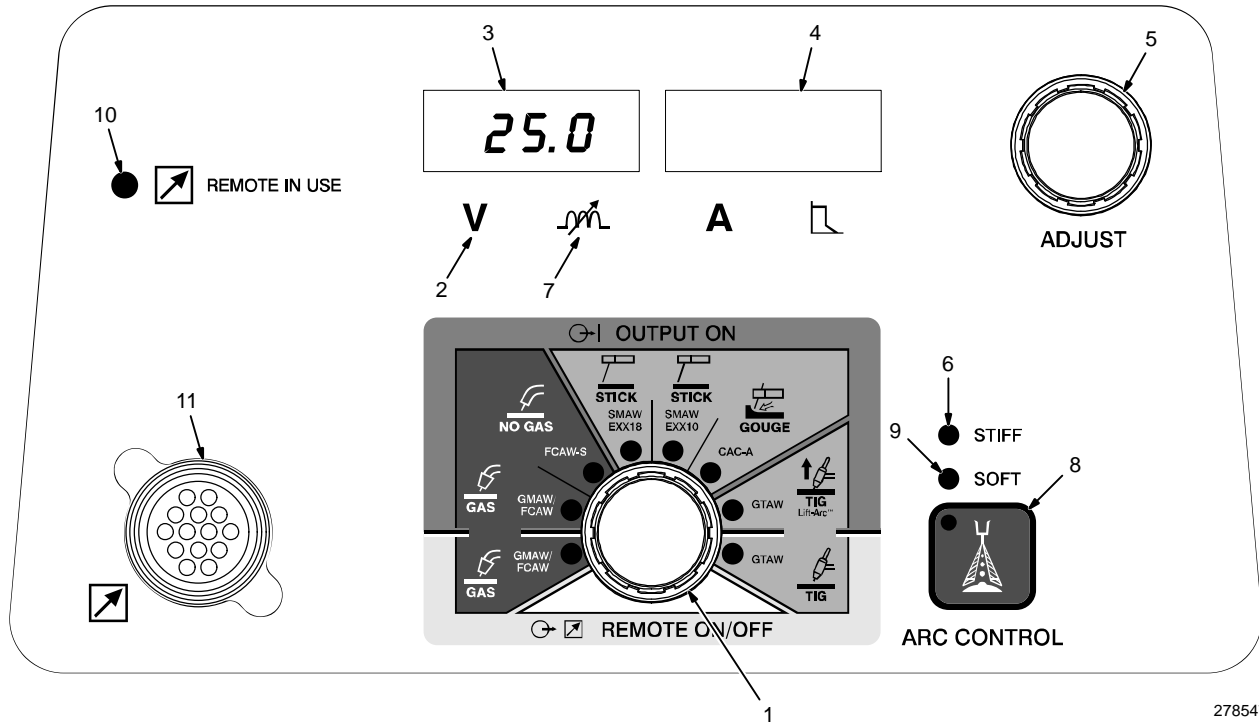
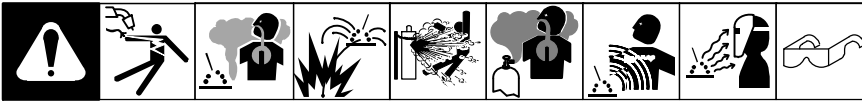

278547-B

**⚠** Weld terminals are energized through the remote control in this mode.

- 1 Mode Switch
- 2 Volts Indicator
- 3 Left Display
- 4 Right Display
- 5 Adjust Control
- 6 Arc Control Indicator For Wire Modes
- 7 Arc Control Indicator
- 8 Arc Control Button
- 9 Arc Control Soft Indicator
- 10 Remote In Use Indicator
- 11 Remote 14 Receptacle

### Setup

For typical system connections refer to Section 8-1.

Set Mode Switch to GMAW/FCAW GAS, REMOTE ON/OFF position.

The preset voltage is shown in the Left Display with the Volts Indicator lit.

### Operation

While the Volts Indicator is lit under the Left Display, the Adjust Control is used to set desired preset voltage.

**ℹ** The preset voltage can be adjusted remotely at the wire feeder if the feeder has a voltage control. This voltage control will override the Adjust Control of preset voltage on the welding power source. The Remote In Use indicator will be lit.

**ℹ** An ArcReach remote control is not compatible in this mode.

Pressing the Arc Control button allows adjustment of Arc Control settings.

### Arc Control

Pressing the Arc Control button will cause the Arc Control Indicator to light. Dependent on the setting: the STIFF or SOFT indicator will light and STIF or SOFT will appear on the Left Display. 0 to 25 will appear on the Right Display. If set to 0 neither STIF or SOFT will appear.

Rotate Adjust Control to select desired Arc Control setting from 0 to 25 Soft and 0 to 25 Stiff. Minimum Arc Control setting is Soft 25. Maximum Arc Control setting is Stiff 25. Mid-range setting of 0 is good for most applications. Use lower Arc Control settings to stiffen the arc and reduce puddle fluidity. Use higher Arc Control settings to soften the arc and increase puddle fluidity.

After three seconds of inactivity the Adjust Control will revert back to adjusting preset voltage.

### 8-3. Typical Connection For Voltage-Sensing Feeder GMAW/FCAW, FCAW-S Process

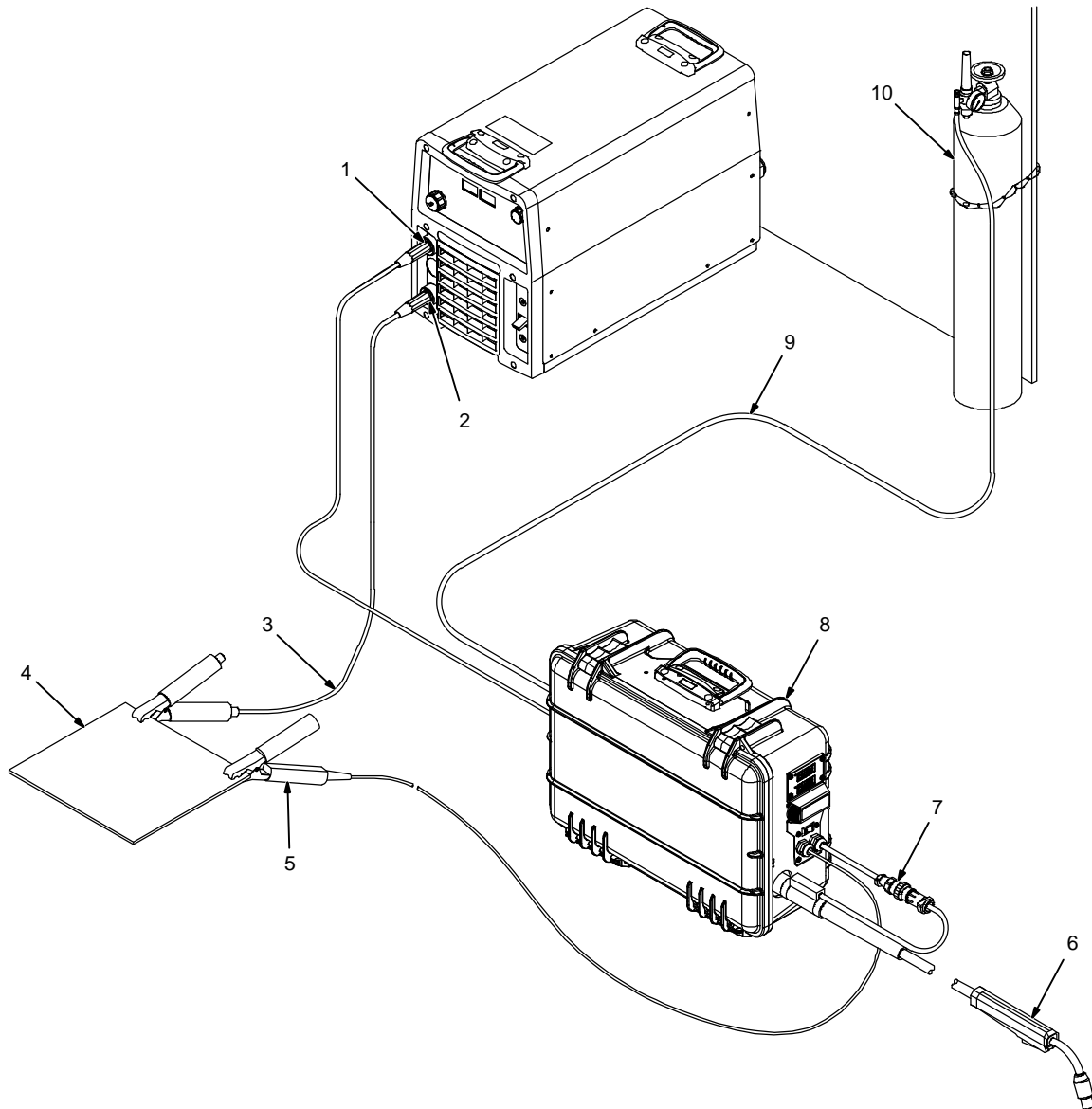
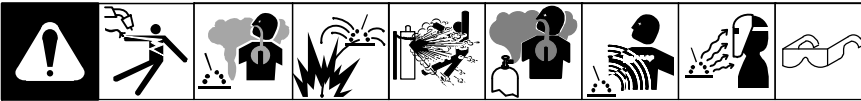

278671-A

**⚠ Turn off power before making connections.**

- 1 Positive (+) Weld Output Terminal
- 2 Negative (-) Weld Output Terminal
- 3 Ground Cable to Workpiece
- 4 Workpiece
- 5 Voltage Sensing Clamp

- 6 Gun
- 7 Gun Trigger Receptacle
- 8 Wire Feeder
- 9 Gas Hose
- 10 Gas Cylinder

Use of shielding gas is dependant on Wire Type.

**ℹ** The connection diagram illustrates DCEP (reverse polarity) suitable for all wires except self-shielded FCAW-S. The majority of self-shielded FCAW-S wires require DCEN (straight polarity).

## 8-4. V-Sense Feeder Welding Modes - GMAW/FCAW, FCAW-S Output ON

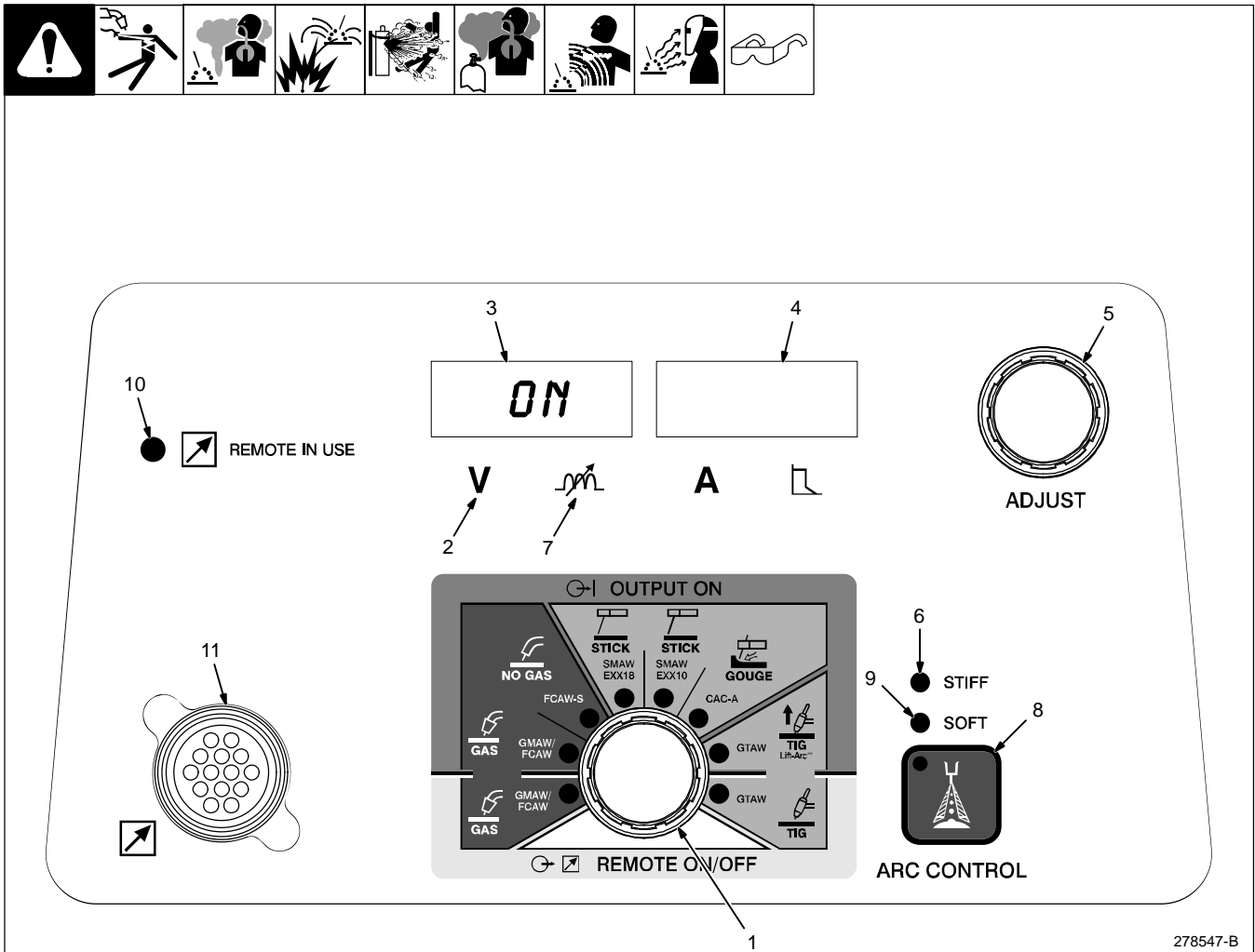

278547-B

**⚠** Weld terminals are energized at all times in these modes.

- 1 Mode Switch
- 2 Volts Indicator
- 3 Left Display
- 4 Right Display
- 5 Adjust Control
- 6 Arc Control Stiff Indicator
- 7 Arc Control Indicator For Wire Modes
- 8 Arc Control Button
- 9 Arc Control Soft Indicator
- 10 Remote In Use Indicator
- 11 Remote 14 Receptacle

### Setup

For typical system setup connections refer to Section 8-3.

Set Mode Switch to FCAW-S NO GAS, or GMAW/FCAW GAS, OUTPUT ON position.

The Left Display toggles between ON and preset arc voltage with the Volts indicator lit.

*☞* If associated to an ArcReach feeder

with Cable Length Compensation the voltage display on the power source will show ACC.

### Operation

While the Volts indicator is lit under the Left Display, the Adjust Control is used to set desired preset voltage.

*☞* The Left Display toggling momentarily pauses while the preset voltage is adjusted.

If a remote control is connected to the Remote 14 Receptacle and used for voltage adjustment, the adjustment will have full range of preset voltage. The Remote In Use indicator will be lit.

*☞* If an ArcReach device is used for voltage adjustment, it will have full range of the preset voltage. Dependent on the capabilities of the device, it may have the ability to override parameter adjustments and mode switch setting. The Remote In Use indicator will be lit. An ArcReach device will override a remote control connected to the Remote 14 Receptacle.

*☞* If using an ArcReach feeder capable of communication while welding, the voltage can be adjusted while welding.

Pressing the Arc Control button allows adjustment of Arc Control settings.

### Arc Control

Pressing the Arc Control button will cause the Arc Control indicator to light. Dependent on the setting: the STIFF or SOFT indicator will light and STIF or SOFT will appear on the Left Display. 0 to 25 will appear on the Right Display. If set to 0 neither STIF or SOFT will appear.

Rotate Adjust Control to select desired Arc Control setting from 0 to 25 Soft and 0 to 25 Stiff. Minimum Arc Control setting is Soft 25. Maximum Arc Control setting is Stiff 25. Mid-range adjustment of 0 is good for most applications. Use lower Arc Control settings to stiffen the arc and reduce puddle fluidity. Use higher Arc Control settings to soften the arc and increase puddle fluidity.

After three seconds of inactivity the Adjust Control will revert back to adjusting preset voltage.

# SECTION 9 – SMAW/CAC-A OPERATION

## 9-1. Typical Connection For SMAW And CAC-A Process

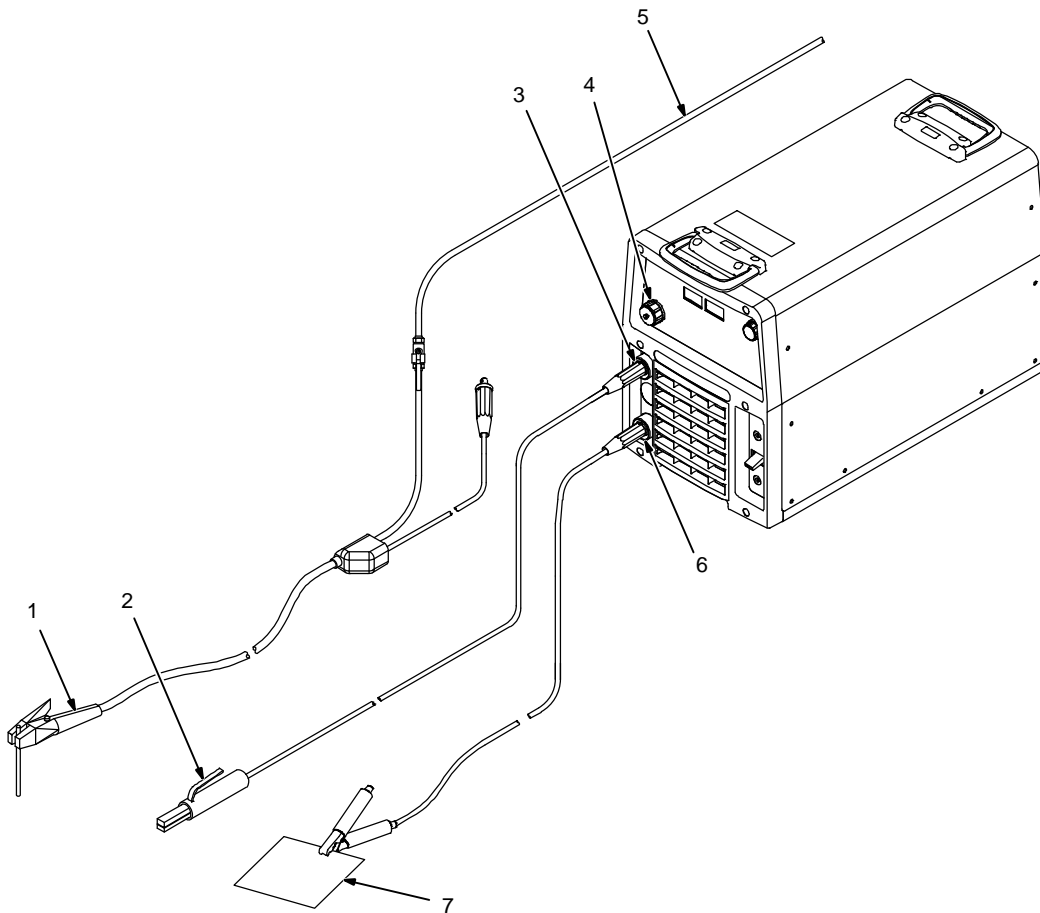
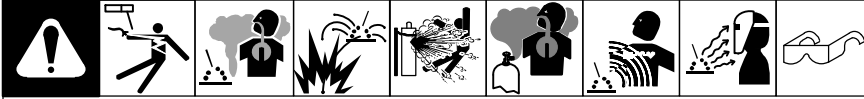

278672-A

**⚠ Turn off power before making connections.**

1 Electrode Holder  
(Carbon Arc)

For CAC-A process connect carbon arc

cutting torch to to positive weld output terminal.

2 Electrode Holder  
3 Positive (+) Weld Output Terminal  
4 Remote 14 Receptacle

Connect desired remote control to remote 14 receptacle as required.

5 Compressed Air Line  
6 Negative (-) Weld Output Terminal  
7 Workpiece



## 9-2. Typical Connection For ArcReach Stick/TIG Remote (SMAW And CAC-A Process)

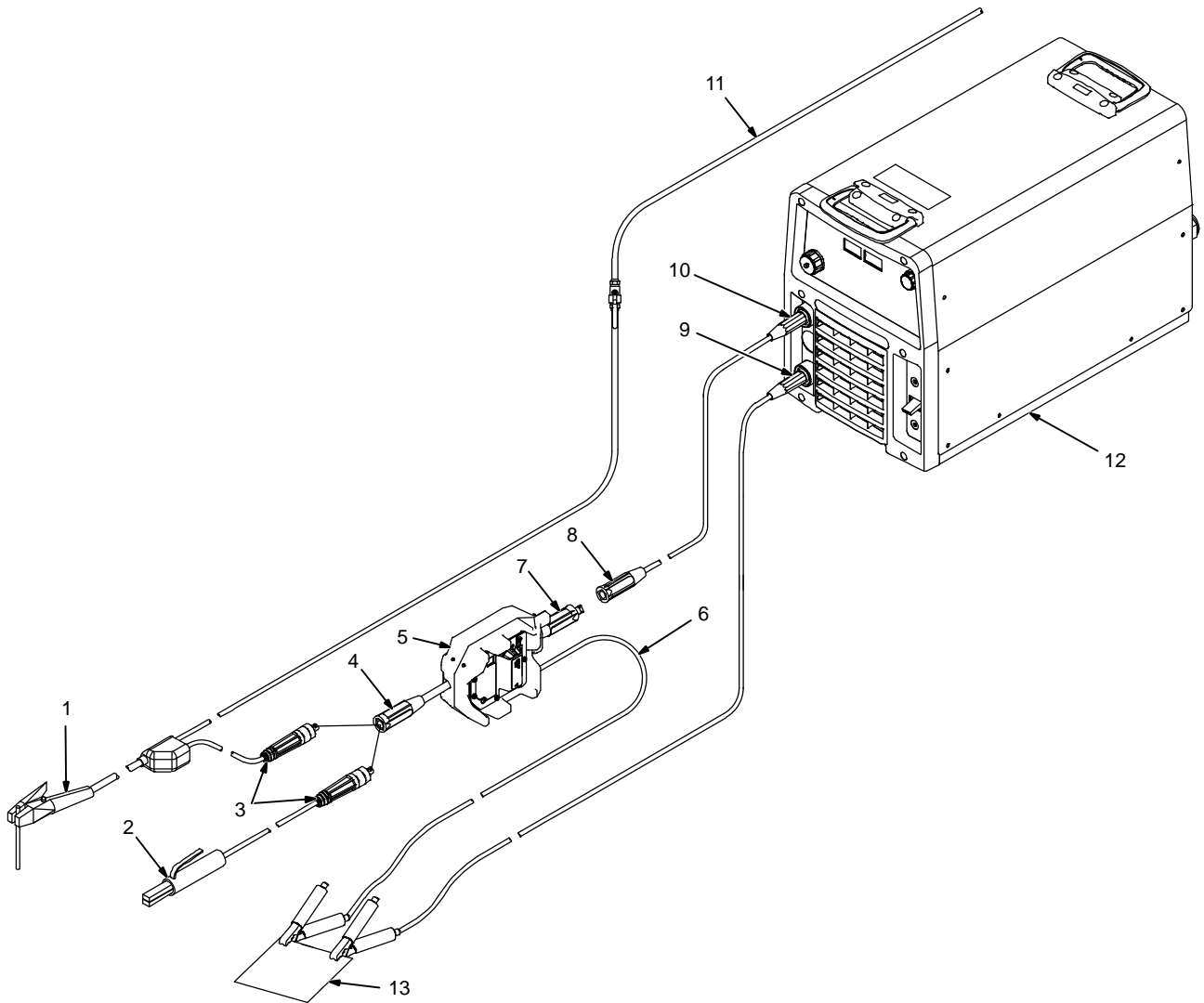
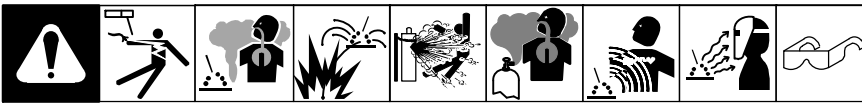

Ref. 280218-A

**⚠ Turn Off welding power source before making any input or output weld cable connections.**

**⚠ Turn Off welding power source before handling or moving voltage sensing clamp. Weld voltage is present at voltage sensing clamp when welding power source is on. This condition exists even if Polarity Indicators and Amps/Arc Control Display on this remote are not lit.**

**ℹ** When the ArcReach Stick/TIG Remote is connected to the power source as electrode positive, the remote will set the welding power source to a stick/gouge mode. The electrode positive

(Stick) indicator on the remote will be lit.

- 1 Electrode Holder CAC-A (Carbon Arc)
- 2 Electrode Holder SMAW (Stick)
- 3 Male Connector (User Supplied LC-40 Style Male Connector)
- 4 Output Weld Cable (With Supplied Female Connector)
- 5 ArcReach Stick/TIG Remote
- 6 Voltage Sensing Lead

**ℹ** An additional weld cable may be used in parallel with the remote if weld current exceeds amperage rating of the remote.

Attach voltage sensing lead clamp to workpiece.

- 7 Input Weld Cable (With Supplied Male Connector)
- 8 Female Connector (User Supplied LC-40 Style Female Connector)
- 9 Negative (-) Weld Output Terminal Connection for work cable going to workpiece.
- 10 Positive (+) Weld Output Terminal Connection for weld cable going to remote.
- 11 Compressed Air Line
- 12 Welding Power Source
- 13 Workpiece

## 9-3. Stick Welding Modes - SMAW EXX18, SMAW EXX10, CAC-A Gouge - Output ON

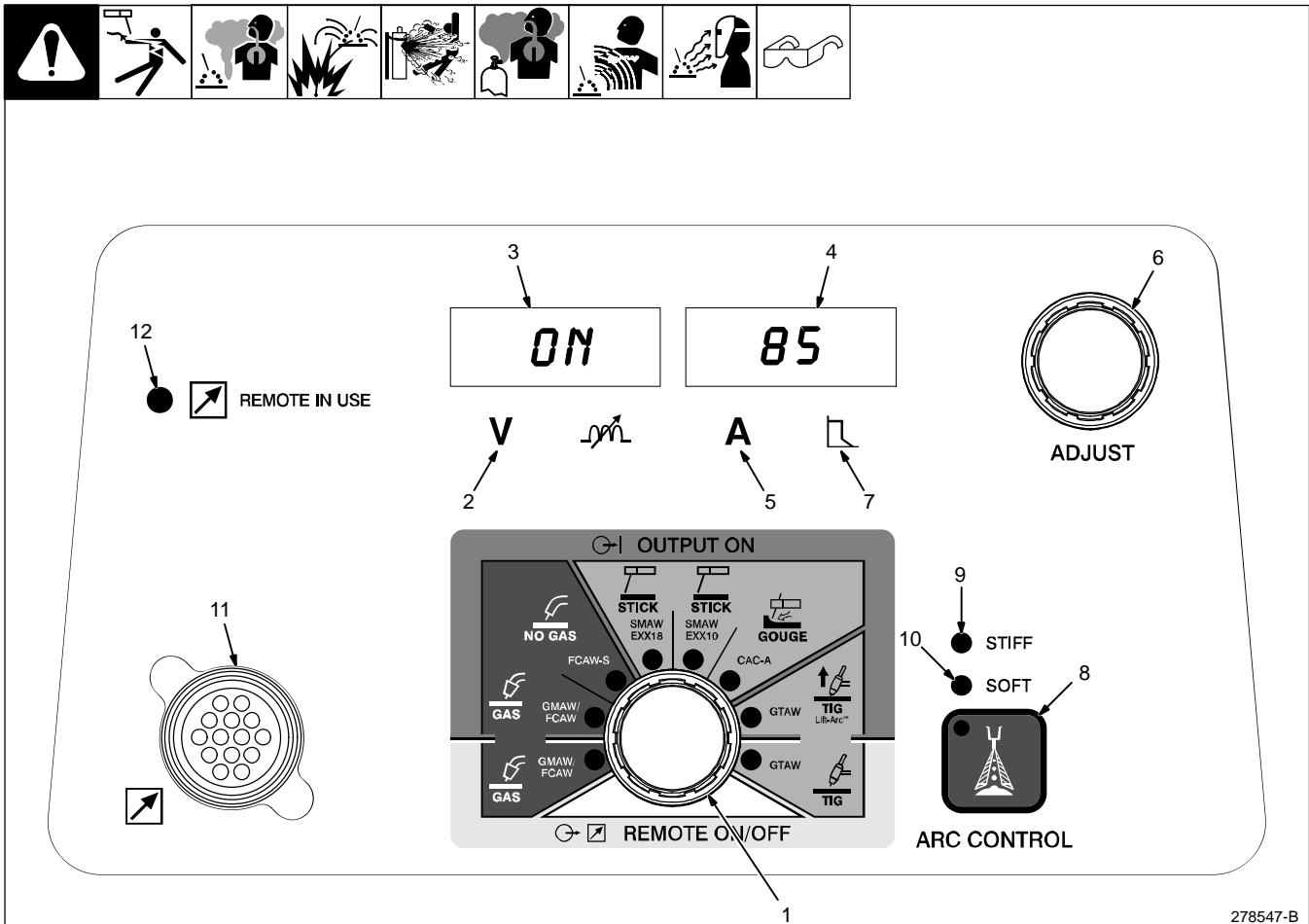

278547-B

### **⚠** Weld terminals are energized at all times in this mode.

- 1 Mode Switch
- 2 Volts Indicator
- 3 Left Display
- 4 Right Display
- 5 Amps Indicator
- 6 Adjust Control
- 7 Arc Control Indicator For Stick Modes
- 8 Arc Control Button
- 9 Arc Control Stiff Indicator
- 10 Arc Control Soft Indicator
- 11 Remote 14 Receptacle
- 12 Remote In Use Indicator

#### Setup

For typical system connections refer to Section 9-1.

Set Mode Switch to SMAW EXX18, SMAW EXX10, CAC-A Gouge - Output ON position.

ON is shown in the Left Display. Preset amperage is shown in the Right Display with the Amps Indicator lit.

#### Operation

While the Amps Indicator is lit under the Right Display, the Adjust Control is used to set desired preset amperage.

Pressing the Arc Control button allows adjustment of Arc Control and Programmable

Hot Start settings.

☞ If a remote control is connected to the Remote 14 Receptacle and used for amperage adjustment, the adjustment will function as a percentage of the preset amperage. The Remote In Use indicator will be lit.

☞ If an ArcReach device is used for amperage adjustment, it will have full range of the preset amperage. If using an ArcReach device capable of communication while welding, the amperage can be adjusted while welding. Dependent on the capabilities of the device, it may have the ability to override parameter adjustments and mode switch setting. The Remote In Use indicator will be lit. An ArcReach device will override a remote control connected to the Remote 14 Receptacle.

☞ For best results at the end of the weld, pull back the electrode quickly to extinguish the arc.

☞ See Section 9-5 for information regarding Alternate Configurations.

#### Arc Control

Pressing the Arc Control button will cause the Arc Control Indicator to light. Dependent on the setting: the STIFF or SOFT indicator will light and STIF or SOFT will appear on the Left Display. 0 to 25 will appear on the

Right Display. If set to 0 neither STIF or SOFT will appear.

Rotate Adjust Control to select desired Arc Control setting from 0 to 25 Soft and 0 to 25 Stiff. Minimum Arc Control setting is Soft 25. Maximum Arc Control setting is Stiff 25. Mid-range adjustment of 0 is good for most applications.

Arc Control allows the arc characteristics, soft versus stiff, to be changed for specific applications and electrodes. Lower the Arc Control setting for smooth running electrodes like E7018 and increase the Arc Control setting for stiffer, more penetrating electrodes like E6010.

After three seconds of inactivity the Adjust Control will revert back to adjusting preset amperage.

☞ While in Air Carbon Arc (CAC-A) mode, Arc Control is not adjustable.

#### Hot Start Time

Press and hold the Arc Control button until HOT.S appears on the left display. Rotate Adjust Control to enable Automatic Hot Start Time (AUTO) or to set Hot Start Time from Min (0.1 seconds) to Max (5.0 seconds). A separate Hot Start Time may be set for EXX18 and EXX10 modes.

After three seconds of inactivity the Adjust Control will revert back to adjusting preset amperage.

☞ While in Air Carbon Arc (CAC-A) mode, Hot Start Time is not adjustable.

## 9-4. Optional Low Open Circuit Voltage (OCV) Welding Modes

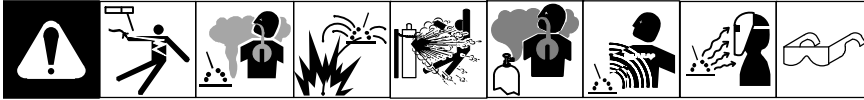

### Low OCV Operation

The unit can be optionally configured for low open circuit voltage (OCV) operation in OUTPUT ON: Wire, Stick, Lift-Arc TIG modes. When the unit is configured for low OCV operation a lower sensing voltage is present between the electrode and the workpiece prior to the electrode touching the workpiece. Consult a Factory Authorized Service Agent for information regarding how to configure the unit for low OCV welding operation.

## 9-5. Alternate Configuration Functions

There are 2 ways that the remote control can be configured to operate on this machine. The configuration of the meters can be changed by placing the process selection switch into either Stick or Gouge modes and turning the output on and off 3-5 times within a few seconds, this can be done by triggering a feeder or by activating the output on-off switch on a remote control. The feeder or remote control must be connected to the remote 14 receptacle. The amperage window will briefly display what mode is selected before returning to a preset display.

C 1

Configuration 1 is the factory default setting. Stick or Gouge modes recognize a remote plugged into the remote 14 receptacle, the amperage window will display the percentage of preset being set from the remote, the panel will set the maximum amperage. An ArcReach device will have full range control and override a remote connected to the remote 14 receptacle.

C 2

In either Stick or Gouge modes Configuration 2 changes the operation of any remote control connected to the remote 14 receptacle. When Configuration 2 is selected either Stick or Gouge modes operate in Panel Only control. Any remote control connected to the remote 14 receptacle will be ignored and have no effect on the output. When either Stick or Gouge modes are active, a decimal point will be displayed in the amperage window. Configuration 2 has no affect on the operation of an ArcReach device.

## Notes

---

---

---

---

---

---

---

---

---

---

---

---

---

---

---

---

---

---

---

---















---

---

---

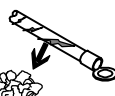
# SECTION 10 – MAINTENANCE & TROUBLESHOOTING

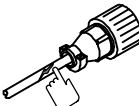
## 10-1. Routine Maintenance

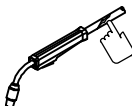
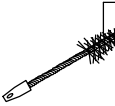
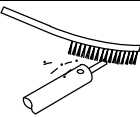
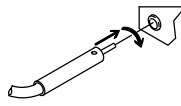
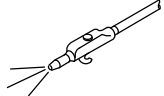
   		 <b>Disconnect power before maintaining.</b>	 <i>Maintain more often during severe conditions.</i>
 ✓ = Check    ◇ = Change    ● = Clean    ☆ = Replace			
Every 3 Months	  <p>Replace Damaged Or Unreadable Labels</p>	 <p>Replace Cracked Torch Body</p>	
	      <p>Repair Or Replace Cracked Cables And Cords</p>		
	   <p>Clean And Tighten Weld Connections</p>		
Every 6 Months	 <p>Blow Out Inside</p>		





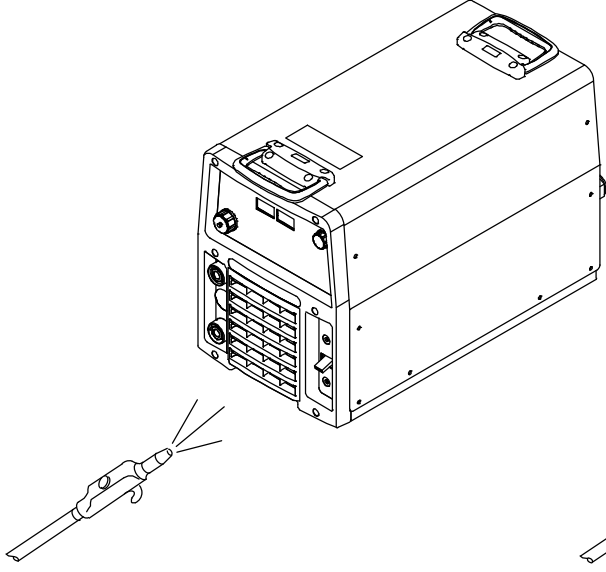
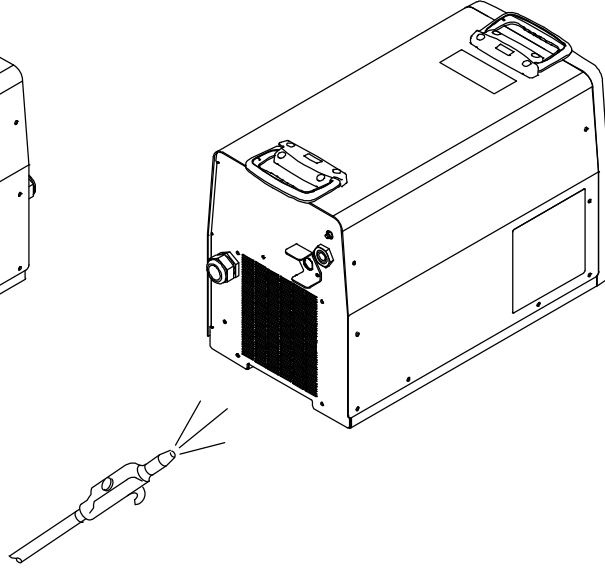









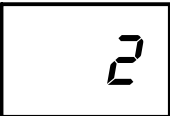

## 10-2. Blowing Out Inside Of Unit

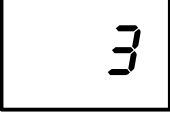

**Do not remove case when blowing out inside of unit.**  
 To blow out unit, direct airflow through front and back louvers as shown.

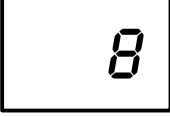
Ref. 278673-A

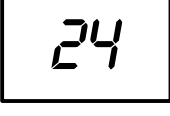
## 10-3. Help Displays

 All directions are in reference to the front of the unit. All circuitry referred to is located inside the unit.

### Help 1, 6, 7 Display

Indicates a malfunction in the primary power circuit. If this display is shown, contact a Factory Authorized Service Agent.

### Help 2 Display

Indicates a malfunction in the thermal protection circuitry. If this display is shown, contact a Factory Authorized Service Agent.

### Help 3 Display

Indicates the left side of the unit has overheated. The unit has shut down to allow the fan to cool it (see Section 4-7). Operation will continue when the unit has cooled.

### Help 5 Display

Indicates the right side of the unit has overheated. The unit has shut down to allow the fan to cool it (see Section 4-7). Operation will continue when the unit has cooled.

### Help 8 Display

Indicates a malfunction in the secondary power circuit of the unit. If this display is shown, contact a Factory Authorized Service Agent.

### Help 24, 25 Display

Indicates machine has reached Duty Cycle limit (see Section 4-7). Unit must be left on to power the fan for cooling. Duty Cycle limit will automatically reset when unit has cooled.

## 10-4. Troubleshooting

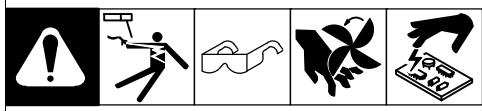

Trouble	Remedy
No weld output; unit completely inoperative.	Place line disconnect switch in On position (see Sections 5-8 and 5-9).
	Check and replace line fuse(s), if necessary, or reset circuit breaker (see Sections 5-8 and 5-9).
	Check for proper input power connections (see Sections 5-8 and 5-9).
No weld output; meter display On.	Input voltage outside acceptable range of variation (see Section 5-7).
	Check, repair, or replace remote control.
	Unit overheated. Allow unit to cool with fan On (see Section 4-7).
Erratic or improper weld output.	Use proper size and type of weld cable (see Section 5-2).
	Clean and tighten all weld connections.
	Check for correct polarity.
No 24 volts AC output at Remote 14 receptacle.	Reset supplementary protector CB2 (see Section 5-5).
Does not associate to another ArcReach device.	Check that Mode Switch is set to an "OUTPUT ON" mode.
	Check owner's manual of the other device for correct method to associate the power source to the other ArcReach device.

## Notes



# SECTION 11 – ELECTRICAL DIAGRAM

<b>⚠ WARNING</b>  <b>ELECTRIC SHOCK HAZARD</b>	<ul style="list-style-type: none"> <li>• Do not touch live electrical parts.</li> <li>• Disconnect input power or stop engine before servicing.</li> <li>• Do not operate with covers removed.</li> <li>• Have only qualified persons install, use, or service this unit.</li> </ul>
---	--

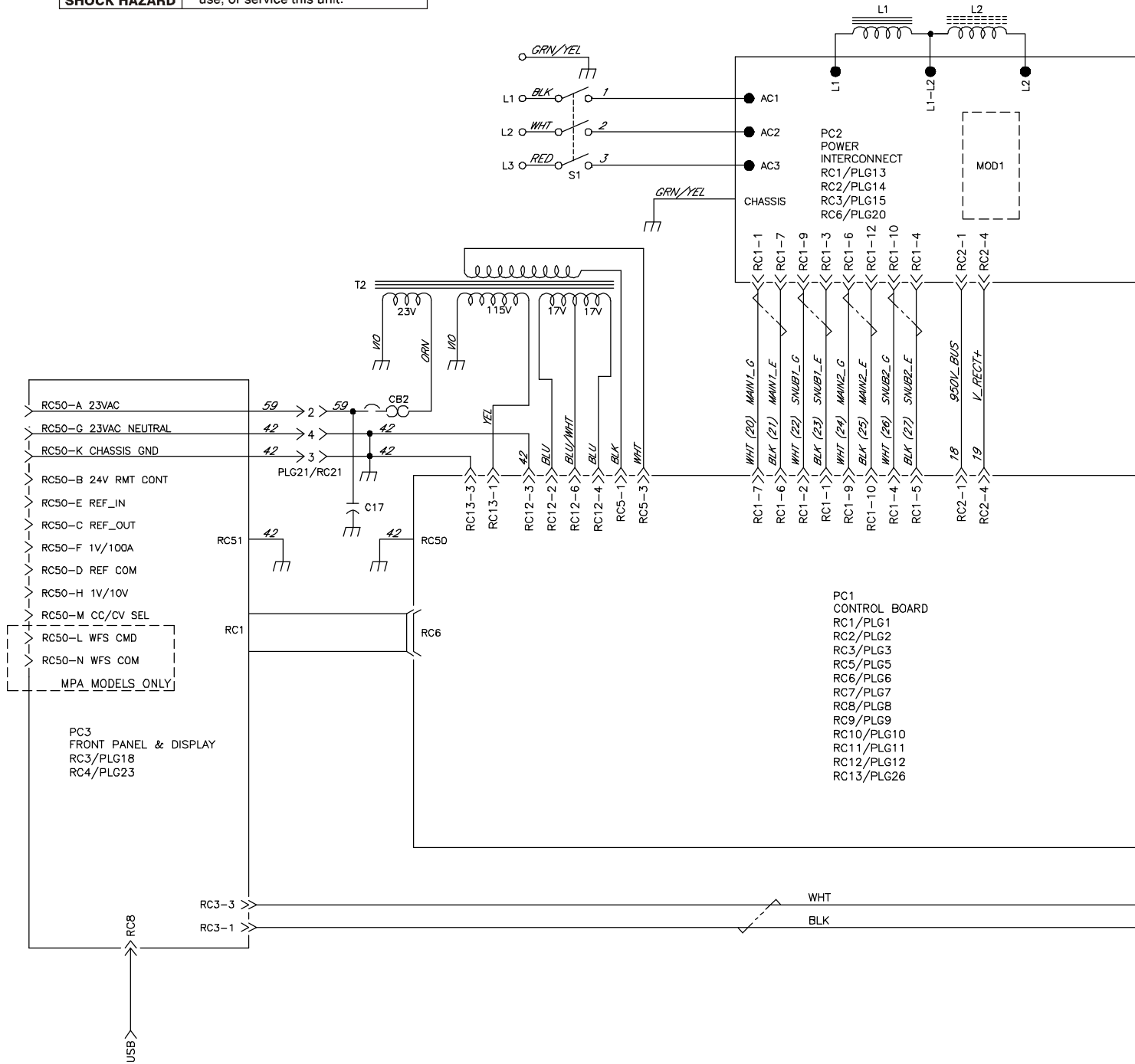
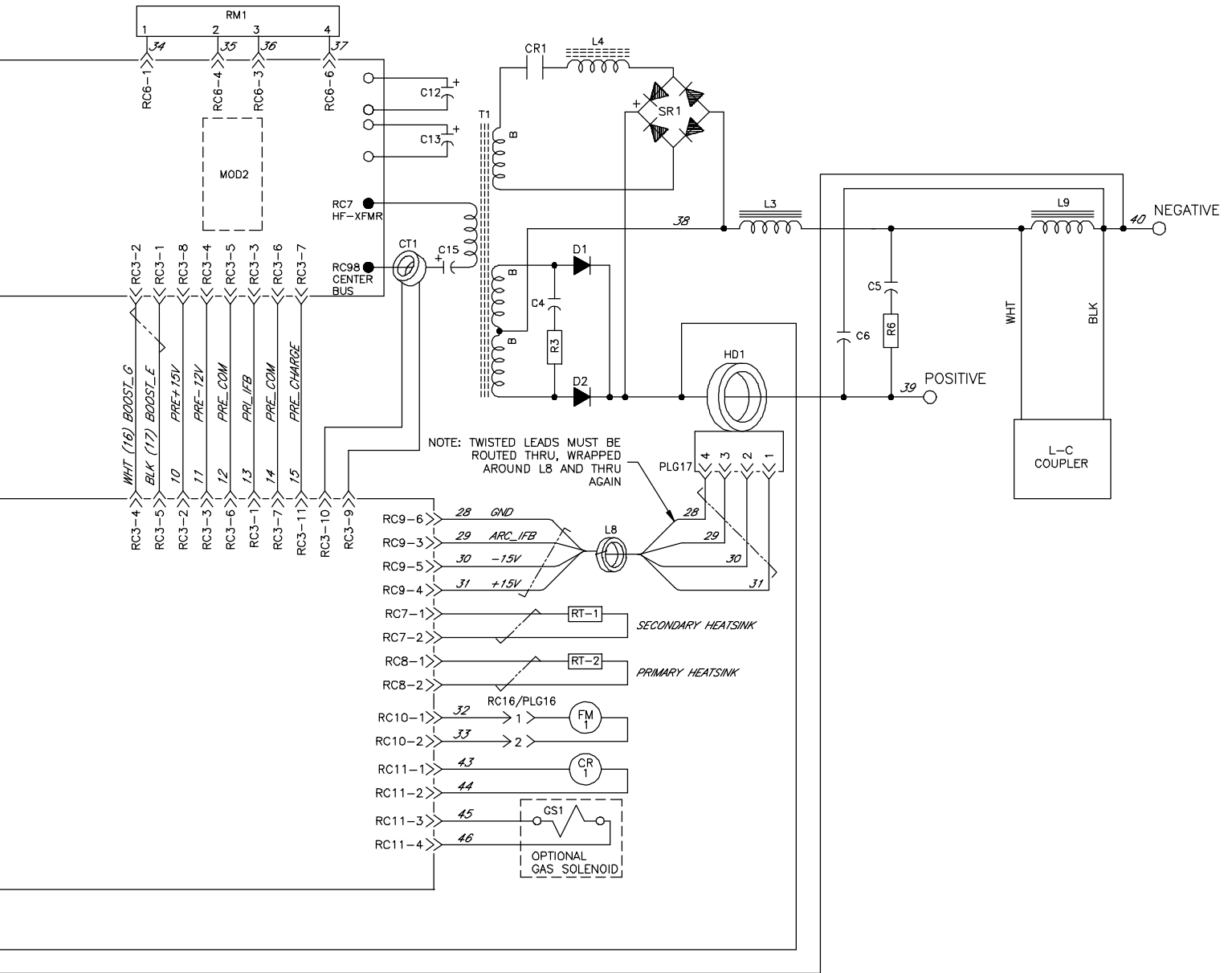

Figure 11-1. Circuit Diagram





# SECTION 12 – PARTS LIST

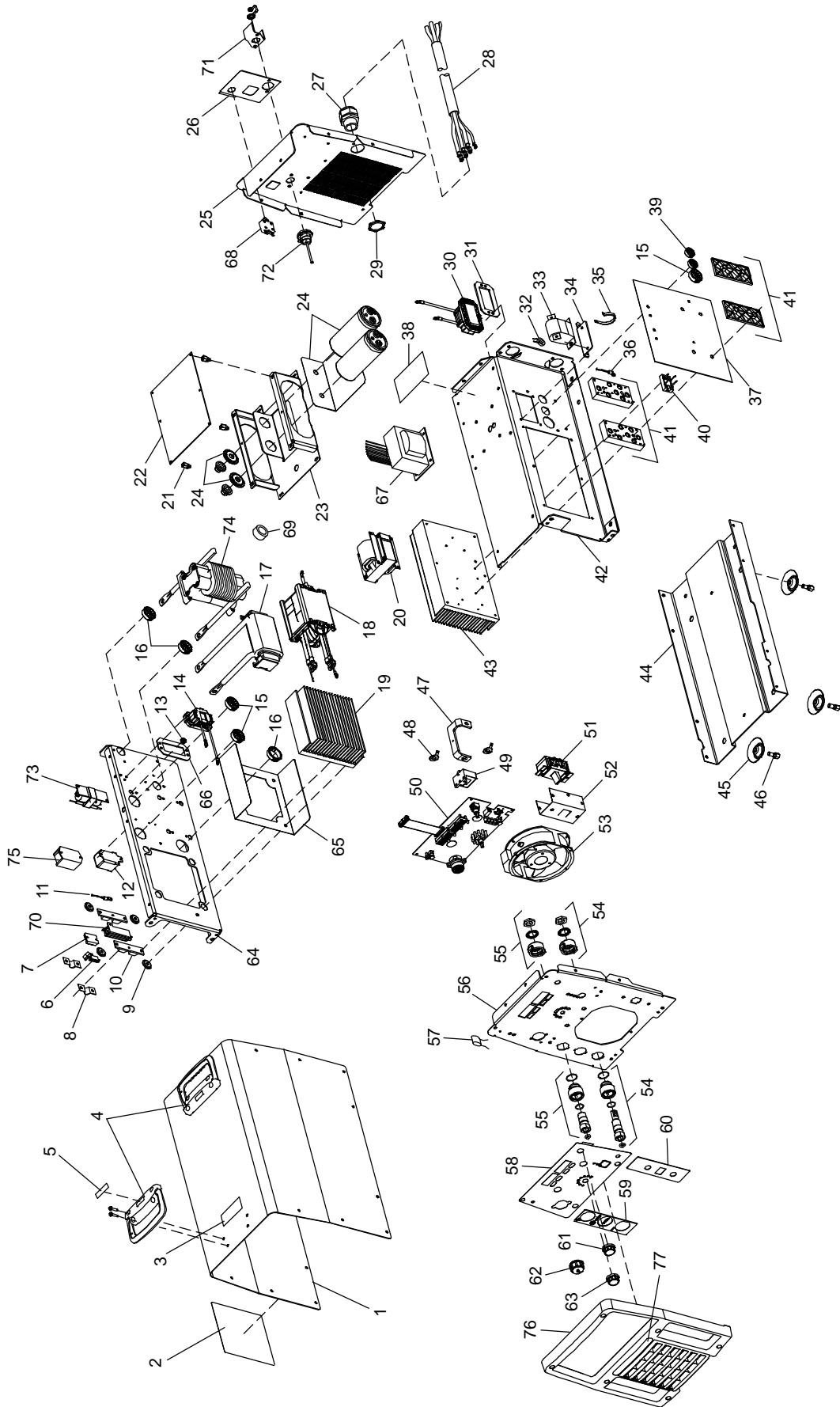

Figure 12-1. Parts Assembly

Available for rent at [reddarc.com](http://reddarc.com)

Item No.	Dia. Mkgs.	Part No.	Description	Quantity
----------	------------	----------	-------------	----------

**Figure 12-1. Parts Assembly**

1		282357	Wrapper W/Insulators (Includes)	1
		175256	Insulator, Side Rh (Not Shown)	2
		282360	Label, Side Red-D-Arc EX 360 (Not Shown)	2
2		274964	Label, Warning General Precautionary (EN/FR/SP)	1
3		275316	Label, Warning Falling Equipment (EN/FR/SP)	1
4		208015	Handle, Rubberized Carrying	2
5		135483	Label, Important Remove These Two Handle Screws	2
6	R3/C4	233052	Resistor/Capacitor	1
7	SR1	199952	Diode Power Module 55 Amp 600V 1PH Fast Recovery	1
8		199840	Bus Bar, Diode	2
9		196355	Insulator, Screw	4
10	D1,D2	201531	Kit, Diode Power Module	2
11	RT1	199798	Thermistor, NTC 30K Ohm @ 25 Deg C 18in Lead	1
12	CR1	255744	Relay, Encl 24VDC Spst 30A/300VAC 4Pin Flange Mtg	1
13		010546	Bushing, Snap-In Nyl .375 Id X .500 Mtg Hole	1
14	L4	218020	Inductor, Boost	1
15		179276	Bushing, Snap-In Nyl 1.000 Id X 1.375 Mtg Hole Cent	5
16		170647	Bushing, Snap-In Nyl 1.312 Id X 1.500 Mtg Hole	1
17	L3	278572	Inductor, Output	1
18	T1	251394	XFMR, HF Litz/Litz W/Boost	1
19		225097	Heat Sink, Lh Rect	1
20	L1	212091	Inductor, Input	1
21		083147	Grommet, Scr No 8/10 Panel Hole .312 Sq .500 High	4
22	PC1	276638	Circuit Card Assy, Control W/Program	1
		216113	Stand-Off Support, PC Card .187 Dia W/P&I .375	2
	PLG1	115091	Housing Rcpt+Skts (Service Kit) RC1	1
	PLG2	201665	Housing Plug+Skts (Service Kit) RC2	1
	PLG3	131056	Housing Rcpt+Skts (Service Kit) RC3	1
	PLG5, 13	131024	Housing Plug+Skts (Service Kit) RC5, 13	1
	PLG7, 8	131054	Housing Plug+Skts (Service Kit) RC7, 8	1
	PLG9	115093	Housing Plug+Skts (Service Kit) RC9	1
	PLG10, 11	115094	Housing Plug+Skts (Service Kit) RC10, 11	1
	PLG12	115092	Housing Plug+Skts (Service Kit) RC12	1
23		263023	Bracket, Mtg Capacitor/PC Board	1
24		219930	Kit, Capacitor Elcltl Replacement (Includes)	1
	C12,13	277164	Capacitor, Elcltl 1800 UF 500 VDC Can 2.52 Dia	2
		251701	Adapter, Nut Capacitor	2
		217040	Nut, Nylon M12 Thread Capacitor Mounting	2
		229327	Screw, M 5-.8X 12 Hex Hd-Phl 8.8 Pld Sems Cir	4
		263052	Insulator, Capacitor Mtg	1
25		+279838	Panel, Rear W/Studs	1
26		273374	Label, Panel Rear XMT CC/CV MPA W/USB	1
27		215980	Bushing, Strain Relief .709/.984 Id X1.375 Mtg Hole	1
28		219487	Cable, Power	1
29		234126	Nut, Conduit 1.000 Npt Knurled	1
30	L2	218018	Inductor, Pre-Regulator	1
31		218566	Gasket, Inductor Mounting	1
32	CT1	196231	XFMR, Current Sensing 200/1	1
33	C15	196143	Capacitor, Polyp Met Film 16. Uf 400 VAC 10%	1
34		216117	Bracket, Mtg Capacitor Series	1
35		108020	Clamp, Stl Cush 1.625 Dia X .281 Mtg Hole	1
36	RT2	199798	Thermistor, NTC 30K Ohm @ 25 Deg C 18in Lead	1
37	PC2	263676	Circuit Card Assy, Interconnect W/Label & Clips (Includes)	1
38		219844	Label, Warning Electric Shock/Exploding Parts-Wdles	1
	PLG13	132003	Housing Plug+Pins (Service Kit) RC1	1
	PLG14	201665	Housing Plug+Pins (Service Kit) RC2	1
	PLG15	115092	Housing Plug+Pins (Service Kit) RC3	1
	PLG20	115093	Housing Plug+Pins (Service Kit) RC6	1

Item No.	Dia. Mkgs.	Part No.	Description	Quantity
----------	------------	----------	-------------	----------

**Figure 12-1. Parts Assembly (Continued)**

39		153403	Bushing, Snap-In Nyl .750 Id X 1.000 Mtg Hole Cent	2
40	RM1	205751	Module, Power Resistor W/Plug	1
41		261556	Kit, Input/Pre-Regulator And Inverter Module	1
42		279835	Windtunnel, Rh W/Stud	1
43		196330	Heat Sink, Power Module	1
44		+278542	Base Assy, W/Studs	1
45		229325	Foot, Mtg Unit	4
46		176736	Screw, Mtg Foot	4
47		212074	Bus Bar, Output	1
48		253430	Terminal, Connector Friction 0.406 Id	2
49	HD1	182918	Transducer, Current 400A Module Supply V +/- 15V	1
50	PC3	280231	Circuit Card Assy, Display XMT 350 FieldPro	1
	PLG18	131204	Housing Plug+Pins (Service Kit) RC2	1
	PLG23	131054	Housing Rcpt+Skts, (Service Kit) RC3	1
51	S1	244920	Switch, Tgl 3Pst 40A 600VAC Scr Term Wide Tgl	1
52		176226	Insulator, Switch Power	1
53	FM1	213072	Fan, Muffin 115V 60Hz 3400 RPM 6.378 Mtg Holes	1
	PLG16	131054	Housing Plug+Skts (Service Kit)	1
	RC16	135635	Housing Plug+Pins (Service Kit)	1
54		258713	Rcpt Assy, Tw Lk Insul Fem (Tweco) Bolted (Includes)	1
		250037	Insulator, Bulkhead Front	1
		250039	Insulator, Bulkhead Rear	1
		185714	Washer, Tooth 22mmid X 31.5mmod 1.310-1mmt Intern	1
		185717	Nut, M20-1.5 1.00Hex .19h Brs Locking	1
		185718	O-Ring, 0.989 Id X 0.070 H	1
		267367	Receptacle, Twist Lock Tweco .890 Od W/O-Ring (Includes)	1
		186228	O-Ring, 0.739 Id X 0.070 H	1
54		258711	Rcpt Assy, Tw Lk Insul Fem (Dinse) Bolted (Includes)	1
		250037	Insulator, Bulkhead Front	1
		250039	Insulator, Bulkhead Rear	1
		185714	Washer, Tooth 22Mmid X 31.5Mmod 1.310-1Mmt Intern	1
		185717	Nut, M20-1.5 1.00Hex .19h Brs Locking	1
		185718	O-Ring, 0.989 Id X 0.070 H	1
		257994	Rcpt, Tw Lk Insul W/O-Ring (Includes)	1
55		258712	Rcpt Assy, Tw Lk Insul Fem (Tweco) (Includes)	1
		250037	Insulator, Bulkhead Front	1
		250039	Insulator, Bulkhead Rear	1
		185714	Washer, Tooth 22mmid X 31.5mmod 1.310-1mmt Intern	1
		185717	Nut, M20-1.5 1.00Hex .19H Brs Locking	1
		185718	O-Ring, 0.989 Id X 0.070 H	1
		267366	Receptacle, Twist Lock Tweco .890 Od W/O-Ring (Includes)	1
		186228	O-Ring, 0.739 Id X 0.070 H	1
55		258710	Rcpt Assy, Tw Lk Insul Fem (Dinse) (Includes)	1
		250037	Insulator, Bulkhead Front	1
		250039	Insulator, Bulkhead Rear	1
		185714	Washer, Tooth 22Mmid X 31.5Mmod 1.310-1Mmt Intern	1
		185717	Nut, M20-1.5 1.00Hex .19H Brs Locking	1
		185718	O-Ring, 0.989 Id X 0.070 H	1
		257995	Rcpt, Tw Lk Insul W/O-Ring (Includes)	1
		186228	O-Ring, 0.739 Id X 0.070 H	1
56		278546	Panel, Front W/Knockout	1
57	C6	273061	Capacitor Assy, W/Plug & Leads (Voltage Feedback ArcReach)	1
58			Nameplate (Order by Model and Serial Number)	1
59			Label, Connection (Order by Model and Serial Number)	1
60			Label, Power (Order by Model and Serial Number)	1
61		266591	Knob, Encoder 1.250 Dia X 6mm Id Push On W/Spring	1
62		268085	Conn, Circ Ms Protective Cap Size 20 Nylon	1
63		245663	Knob, Encoder 1.250 Dia X .250 Id Push On W/Spring	1
64		+278581	Windtunnel, Lh W/Studs	1
65		211503	Insulator, Heat Sink	1

Item No.	Dia. Mkgs.	Part No.	Description	Quantity
----------	------------	----------	-------------	----------

**Figure 12-1. Parts Assembly (Continued)**

... 66		227746	.. Gasket, Inductor Mounting	1
... 67	T2	268830	.. XFMR, Control 665V 336VA Syn Aux Pwr	1
... 68	CB2	083432	.. Supplementary Pro,Man Reset 1P 10A 250VAC Frict	1
... 69	L8	241027	.. Core, Toroidal	1
... 70		278555	.. Filter Resistor Assembly, XMT350 FieldPro	1
... 71		274166	.. Bracket, USB	1
... 72		273211	.. Cable, USB 2.0 A-A Male 1Meter Panel-Mount IP-67	1
... 73		273124	.. Filter Cap Assembly, ArcReach 16uF	1
... 74	L9	278391	.. Inductor, WCC	1
... 75		278560	.. Module, WCC	1
... 76		278275	.. Bezel, Front	1
... 77		282361	.. Label, Nameplate Red-D-Arc EX 360 CC/CV	1

+When ordering a component originally displaying a precautionary label, the label should also be ordered.  
**BE SURE TO PROVIDE MODEL AND SERIAL NUMBER WHEN ORDERING REPLACEMENT PARTS.**

# SECTION 13 – OPEN SOURCE LICENSE NOTICES

---

For ST Liberty License (STM32 Cube, ST USB Host, ST USB Device, ST FATFS, ST CMSIS):

Copyright© 2014, 2015 STMicroelectronics International N.V. All rights reserved.

Redistribution and use in source and binary forms, with or without modification, are permitted, provided that the following conditions are met:

- 1 Redistribution of source code must retain the above copyright notice, this list of conditions and the following disclaimer.
- 2 Redistributions in binary form must reproduce the above copyright notice, this list of conditions and the following disclaimer in the documentation and/or other materials provided with the distribution.
- 3 Neither the name of STMicroelectronics nor the names of other contributors to this software may be used to endorse or promote products derived from this software without specific written permission.
- 4 This software, including modifications and/or derivative works of this software, must execute solely and exclusively on microcontroller or microprocessor devices manufactured by or for STMicroelectronics.
- 5 Redistribution and use of this software other than as permitted under this license is void and will automatically terminate your rights under this license.

THIS SOFTWARE IS PROVIDED BY STMICROELECTRONICS AND CONTRIBUTORS "AS IS" AND ANY EXPRESS, IMPLIED OR STATUTORY WARRANTIES, INCLUDING, BUT NOT LIMITED TO, THE IMPLIED WARRANTIES OF MERCHANTABILITY, FITNESS FOR A PARTICULAR PURPOSE AND NON-INFRINGEMENT OF THIRD PARTY INTELLECTUAL PROPERTY RIGHTS ARE DISCLAIMED TO THE FULLEST EXTENT PERMITTED BY LAW. IN NO EVENT SHALL STMICROELECTRONICS OR CONTRIBUTORS BE LIABLE FOR ANY DIRECT, INDIRECT, INCIDENTAL, SPECIAL, EXEMPLARY, OR CONSEQUENTIAL DAMAGES (INCLUDING, BUT NOT LIMITED TO, PROCUREMENT OF SUBSTITUTE GOODS OR SERVICES; LOSS OF USE, DATA, OR PROFITS; OR BUSINESS INTERRUPTION) HOWEVER CAUSED AND ON ANY THEORY OF LIABILITY, WHETHER IN CONTRACT, STRICT LIABILITY, OR TORT (INCLUDING NEGLIGENCE OR OTHERWISE) ARISING IN ANY WAY OUT OF THE USE OF THIS SOFTWARE, EVEN IF ADVISED OF THE POSSIBILITY OF SUCH DAMAGE.

For ARM CMSIS:

Copyright© 2009–2015, 2010–2014, 2010–2015, ARM Limited.

All rights reserved.

Redistribution and use in source and binary forms, with or without modification, are permitted provided that the following conditions are met:

- Redistributions of source code must retain the above copyright notice, this list of conditions and the following disclaimer.
- Redistributions in binary form must reproduce the above copyright notice, this list of conditions and the following disclaimer in the documentation and/or other materials provided with the distribution.
- Neither the name of ARM nor the names of its contributors may be used to endorse or promote products derived from this software without specific prior written permission.

THIS SOFTWARE IS PROVIDED BY THE COPYRIGHT HOLDERS AND CONTRIBUTORS "AS IS" AND ANY EXPRESS OR IMPLIED WARRANTIES, INCLUDING, BUT NOT LIMITED TO, THE IMPLIED WARRANTIES OF MERCHANTABILITY AND FITNESS FOR A PARTICULAR PURPOSE ARE DISCLAIMED. IN NO EVENT SHALL COPYRIGHT HOLDERS AND CONTRIBUTORS BE LIABLE FOR ANY DIRECT, INDIRECT, INCIDENTAL, SPECIAL, EXEMPLARY, OR CONSEQUENTIAL DAMAGES (INCLUDING, BUT NOT LIMITED TO, PROCUREMENT OF SUBSTITUTE GOODS OR SERVICES; LOSS OF USE, DATA, OR PROFITS; OR BUSINESS INTERRUPTION) HOWEVER CAUSED AND ON ANY THEORY OF LIABILITY, WHETHER IN CONTRACT, STRICT LIABILITY, OR TORT (INCLUDING NEGLIGENCE OR OTHERWISE) ARISING IN ANY WAY OUT OF THE USE OF THIS SOFTWARE, EVEN IF ADVISED OF THE POSSIBILITY OF SUCH DAMAGE.

# Warranty

Effective January 1, 2018

(Equipment with a serial number preface of MJ or newer)

This limited warranty supersedes all previous Miller warranties and is exclusive with no other guarantees or warranties expressed or implied.

LIMITED WARRANTY – Subject to the terms and conditions below, warrants to its original retail purchaser that new equipment sold after the effective date of this limited warranty is free of defects in material and workmanship at the time it is shipped from factory. THIS WARRANTY IS EXPRESSLY IN LIEU OF ALL OTHER WARRANTIES, EXPRESS OR IMPLIED, INCLUDING THE WARRANTIES OF MERCHANTABILITY AND FITNESS.

Within the warranty periods listed below, manufacturer will repair or replace any warranted parts or components that fail due to such defects in material or workmanship. Manufacturer must be notified in writing within thirty (30) days of such defect or failure, at which time manufacturer will provide instructions on the warranty claim procedures to be followed. If notification is submitted as an online warranty claim, the claim must include a detailed description of the fault and the troubleshooting steps taken to identify failed components and the cause of their failure.

Manufacturer shall honor warranty claims on warranted equipment listed below in the event of such a failure within the warranty time periods. All warranty time periods start on the delivery date of the equipment to the original end-user purchaser, and not to exceed twelve months after the equipment is shipped to the distributor.

1. 5 Years Parts — 3 Years Labor
  - \* Original Main Power Rectifiers Only to Include SCRs, Diodes, and Discrete Rectifier Modules
2. 3 Years — Parts and Labor
  - \* Auto-Darkening Helmet Lenses (Except Classic Series) (No Labor)
  - \* Engine Driven Welder/Generators  
**(NOTE: Engines are Warranted Separately by the Engine Manufacturer.)**
  - \* Inverter Power Sources
  - \* Plasma Arc Cutting Power Sources
  - \* Process Controllers
  - \* Semi-Automatic and Automatic Wire Feeders
  - \* Transformer/Rectifier Power Sources
3. 2 Years — Parts and Labor
  - \* Auto-Darkening Helmet Lenses – Classic Series Only (No Labor)
  - \* Auto-Darkening Weld Masks (No Labor)
  - \* Fume Extractors – Capture 5, Filtair 400 and Industrial Collector Series
4. 1 Year — Parts and Labor Unless Specified
  - \* AugmentedArc and LiveArc Welding Systems
  - \* Automatic Motion Devices
  - \* Bernard BTB Air-Cooled MIG Guns (No Labor)
  - \* CoolBelt and CoolBand Blower Unit (No Labor)
  - \* Desiccant Air Dryer System
  - \* External Monitoring Equipment and Sensors
  - \* Field Options  
**(NOTE: Field options are covered for the remaining warranty period of the product they are installed in, or for a minimum of one year — whichever is greater.)**
  - \* RFCS Foot Controls (Except RFCS-RJ45)
  - \* Fume Extractors – Filtair 130, MWX and SWX Series
  - \* HF Units
  - \* ICE/XT Plasma Cutting Torches (No Labor)
  - \* Induction Heating Power Sources, Coolers  
**(NOTE: Digital Recorders are Warranted Separately by the Manufacturer.)**
  - \* Load Banks
  - \* Motor-Driven Guns (except Spoolmate Spoolguns)
  - \* PAPR Blower Unit (No Labor)
  - \* Positioners and Controllers
  - \* Racks
  - \* Running Gear/Trailers
  - \* Spot Welders
  - \* Subarc Wire Drive Assemblies
  - \* TIG Torches (No Labor)
  - \* Tregaskiss Guns (No Labor)
  - \* Water Cooling Systems
  - \* Wireless Remote Foot/Hand Controls and Receivers
  - \* Work Stations/Weld Tables (No Labor)

5. 6 Months — Parts
  - \* Batteries
6. 90 Days — Parts
  - \* Accessory (Kits)
  - \* Canvas Covers
  - \* Induction Heating Coils and Blankets, Cables, and Non-Electronic Controls
  - \* M-Guns
  - \* MIG Guns, Subarc (SAW) Torches, and External Cladding Heads
  - \* Remote Controls and RFCS-RJ45
  - \* Replacement Parts (No labor)
  - \* Spoolmate Spoolguns

Limited Warranty shall not apply to:

1. **Consumable components; such as contact tips, cutting nozzles, contactors, brushes, relays, work station table tops and welding curtains, or parts that fail due to normal wear. (Exception: brushes and relays are covered on all engine-driven products.)**
2. Items furnished by manufacturer, but manufactured by others, such as engines or trade accessories. These items are covered by the manufacturer's warranty, if any.
3. Equipment that has been modified by any party other than manufacturer, or equipment that has been improperly installed, improperly operated or misused based upon industry standards, or equipment which has not had reasonable and necessary maintenance, or equipment which has been used for operation outside of the specifications for the equipment.

MANUFACTURER'S PRODUCTS ARE INTENDED FOR COMMERCIAL AND INDUSTRIAL USERS TRAINED AND EXPERIENCED IN THE USE AND MAINTENANCE OF WELDING EQUIPMENT.

The exclusive remedies for warranty claims are, at manufacturer's option, either: (1) repair; or (2) replacement; or, if approved in writing by manufacturer, (3) the pre-approved cost of repair or replacement at an authorized service station; or (4) payment of or credit for the purchase price (less reasonable depreciation based upon use). Products may not be returned without manufacturer's written approval. Return shipment shall be at customer's risk and expense.

The above remedies are F.O.B. Appleton, WI, or at an authorized service facility. Transportation and freight are the customer's responsibility. TO THE EXTENT PERMITTED BY LAW, THE REMEDIES HEREIN ARE THE SOLE AND EXCLUSIVE REMEDIES REGARDLESS OF THE LEGAL THEORY. IN NO EVENT SHALL MANUFACTURER BE LIABLE FOR DIRECT, INDIRECT, SPECIAL, INCIDENTAL OR CONSEQUENTIAL DAMAGES (INCLUDING LOSS OF PROFIT) REGARDLESS OF THE LEGAL THEORY. ANY WARRANTY NOT PROVIDED HEREIN AND ANY IMPLIED WARRANTY, GUARANTY, OR REPRESENTATION, INCLUDING ANY IMPLIED WARRANTY OF MERCHANTABILITY OR FITNESS FOR PARTICULAR PURPOSE, ARE EXCLUDED AND DISCLAIMED BY MANUFACTURER.

Some US states do not allow limiting the duration of an implied warranty or the exclusion of certain damages, so the above limitations may not apply to you. This warranty provides specific legal rights, and other rights may be available depending on your state. In Canada, some provinces provide additional warranties or remedies, and to the extent the law prohibits their waiver, the limitations set out above may not apply. This Limited Warranty provides specific legal rights, and other rights may be available, but may vary by province.



# Owner's Record

Please complete and retain with your personal records.

---

Model Name	Serial/Style Number
Purchase Date	(Date which equipment was delivered to original customer.)
Distributor	
Address	
City	
State	Zip

---

**Red-D-Arc**  
**Welderentals**  
1-866-RED-D-ARC      [reddarc.com](http://reddarc.com)

---

Contact the Delivering Carrier for:

For assistance in filing or settling claims,  
contact your distributor and/or equipment  
manufacturer's Transportation Department.

File a claim for loss or damage during  
shipment.