

Aero 40

S E R I E S

OPERATOR MANUAL

Aero 40 Series Dry Ice Blast Systems

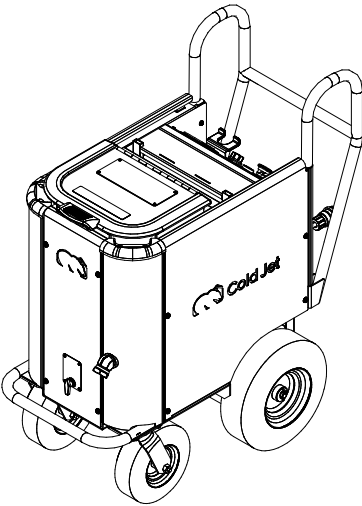

General Safety Precautions.....	6
Electrostatic Discharge.....	7
Carbon Dioxide	8
Machine Safety	9
Front View	12
Rear View.....	13
Control Panel	14
Blast Applicator	15
Start Up.....	18
Shut Down	19
Troubleshooting.....	22
Maintenance	23
Customer Service.....	25
Specifications	26
Symbol Glossary	27
Blast Air Quality	29
Warranty	30



Aero 40

S E R I E S

Model No. 40 Series

This manual illustrates the safety, operation, and maintenance features of the Cold Jet **Aero 40 Series**.

The build and revision level is located on the machine's data plate.

The design contained in this manual was originated by and is the exclusive property of Cold Jet, LLC. It is not to be used in any way detrimental to the interests of Cold Jet, LLC.

No part of this design or manual may be reproduced, transmitted, stored in a retrieval system, or translated into any other language or computer language, in whole or in part, in any form or by any means, whether electronic, mechanical, magnetic, optical, manual or other, without the express written consent of Cold Jet, LLC.

Special Notes

All information contained within this manual, or information derived from exposure to the technology or equipment supplied by Cold Jet, LLC remains "CONFIDENTIAL" between Cold Jet, LLC and the purchaser or authorized user. Any unauthorized transfer of information to any person or company not in the direct employ of Cold Jet, LLC, or not in the direct employ of the purchaser or the authorized user, is strictly prohibited.

Aero 40

S E R I E S

SAFETY

General Safety Precautions



- **NEVER** use a wire tie to hold the applicator trigger in the ON position. (Doing so violates safety regulations, can damage applicator, and voids warranty coverage of applicator.)
- **ALWAYS** turn source air **OFF** and remove the applicator control line before removing the blast hose.
- **ALWAYS** follow the guidelines of the governing codes of your local/national body.
- **NEVER DISCONNECT** the air supply hose without first shutting off the source air and bleeding down the system.
- **ALWAYS WEAR** safety glasses, gloves, 32+NRR ear plugs & ear muffs.
- **NEVER OPERATE** the unit without first reading the Operator Manual.
- **NEVER** exceed recommended hose or blasting unit pressure levels.
- **DO NOT** ever kink the blast hose.
- **ALWAYS ENSURE** that hoses are securely tightened.
- **ALWAYS** electrostatic ground the material being cleaned.
- **CHECK** hoses and tubes for nicks and gouges.
- **NEVER OPERATE** a damaged blasting system.
- **NEVER** mask the ventilation holes.

Electrostatic Discharge

CAUTION: Electrostatic discharge can be hazardous to the operator and the equipment. The static charge of CO₂ varies with the amount of ice and humidity present. Follow these instructions to assure safe operation while blasting.

Static discharge may ignite flammables.

A) PLUG INTO A GROUNDED POWER OUTLET

This is critical for electrostatic dissipation. If the ground is not connected a charge may build up on the unit or the applicator.

B) KNOW YOUR ENVIRONMENT

Electrostatic buildup changes as humidity levels change and will vary by location. Electrostatic discharge is higher at low humidity levels and occurs most often during winter.

C) ATTACH STATIC BOND CABLE

To minimize static between the part being cleaned and the applicator, attach the static bond cable between the blast hose connection and the part.

Carbon Dioxide Safety Precautions

Carbon Dioxide (CO₂) is a naturally occurring non-toxic gas, however caution should be exercised.

- This unit utilizes solid state Carbon Dioxide (Dry Ice) as a blast media.
- Dry Ice is very cold (-110° F / -79° C) and may freeze skin instantly.
- CO₂ is heavier than air, which means it will settle to the ground.
- Always ventilate when blasting.
- CO₂ is nontoxic, non-corrosive, non-conductive and is approved by the FDA and USDA. While exposure to CO₂ gas is not harmful in low concentrations, CAUTION should be exercised when using any material that can DISPLACE OXYGEN.
- Please refer to Carbon Dioxide (CO₂) MSDS sheet for all safety precautions. (available from dry ice supplier.)



Do not allow skin to directly contact dry ice. Always use protective clothing (Thermal Gloves) and eye protection when handling CO₂ solids or when using the blasting unit.

Increased levels of CO₂ when blasting in a confined space can displace breathable oxygen creating a risk of serious injury or death, therefore use of a carbon dioxide monitoring device is required when using in a confined space.



A) ERGONOMICS

CO₂ blasting involves direct discharge of an air powered blasting nozzle. The operator experiences a reactive thrust which increases with blast pressure and air flow. Operator fatigue may become a concern depending on issues such as blasting angle, work area, temperature, operator strength and level of physical conditioning. Do not exceed allowable limits of blast pressure, duty cycle and total blast time as determined by on site health and safety personnel knowledgeable about site-specific conditions and available worker population.

B) LOCK OUT/TAG OUT WARNING

Do not attempt any maintenance procedure unless all input air and electrical sources are locked out and tagged out according to applicable regulations.

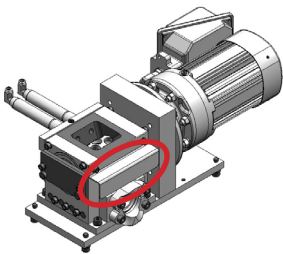

C) FINGER GUARD PRECAUTIONS

The finger guard on the feeder protects from a potential personal injury site located inside the machine. The guard, over the exhaust port, must remain installed at all times to serve it's function.

Aero 40

S E R I E S

YOUR MACHINE

Front View

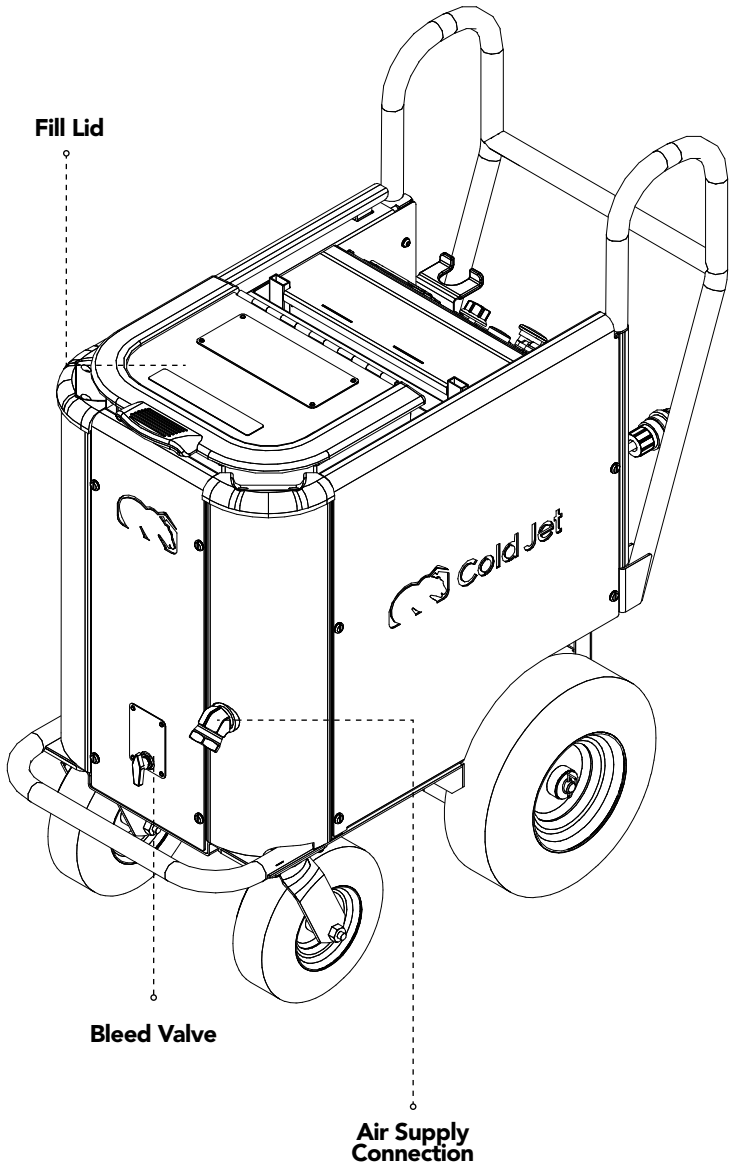

Rear View

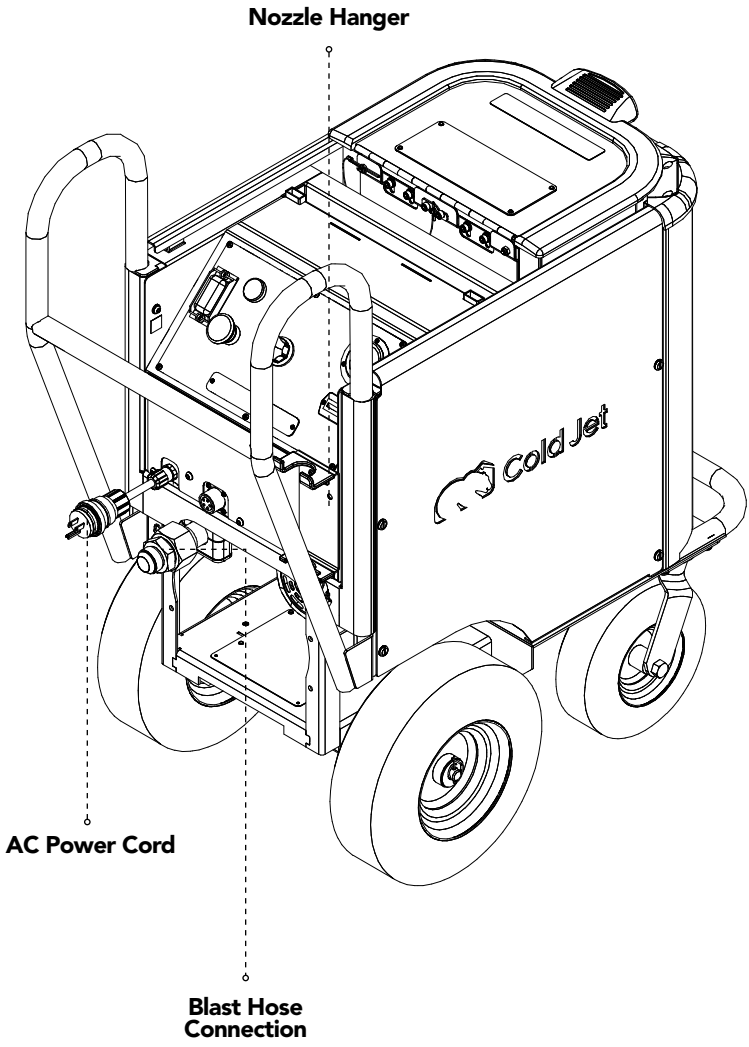

Control Panel

Blast/Power Indicator

Indicator will turn green when you have power to the machine.

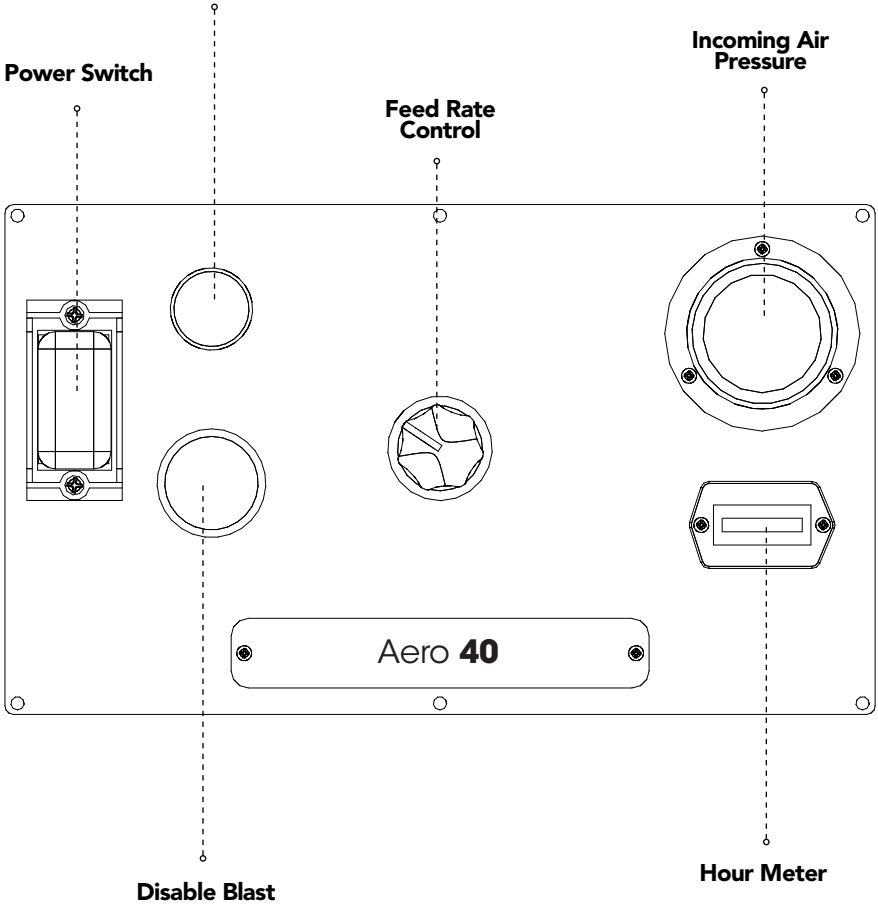

Blast Applicator

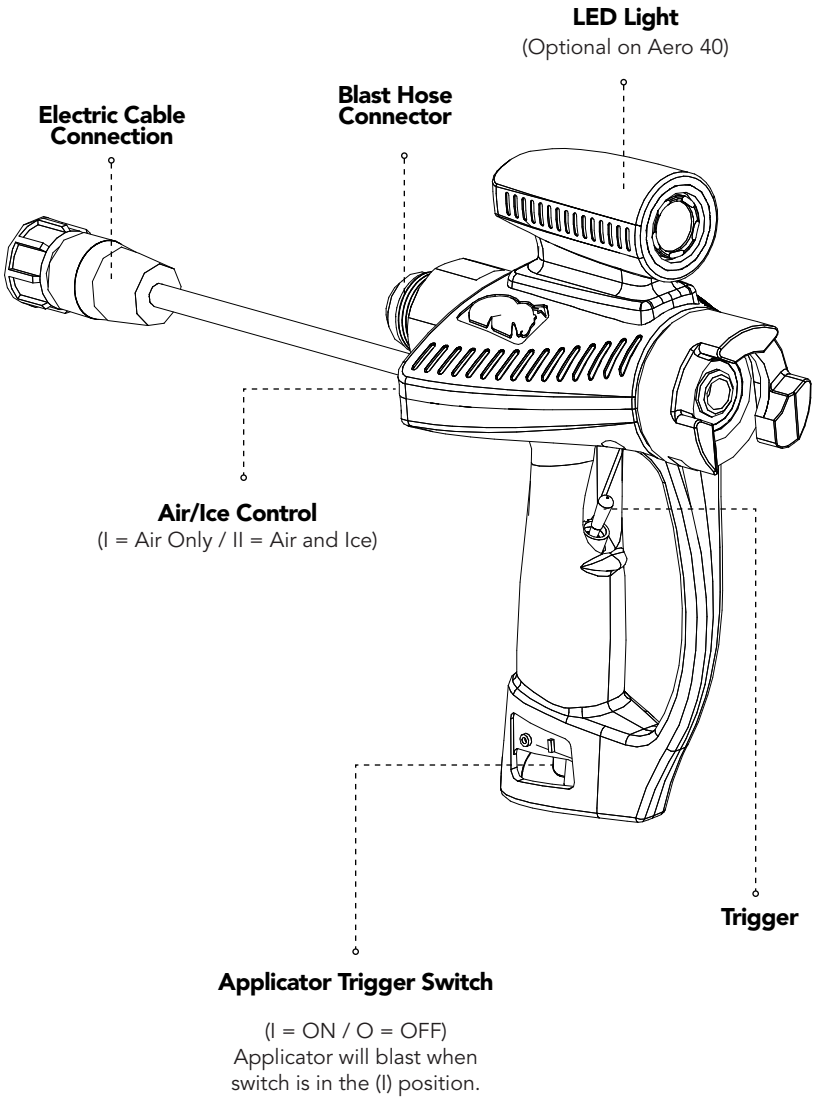

Aero 40

S E R I E S

OPERATION

Start Up

- 1** Make sure the Power Switch is off and the bleed valve is closed.
- 2** Attach the blast hose and control cable to the machine.
- 3** Attach the applicator to the blast hose and control cable.
- 4** Attach a nozzle to the applicator.
- 5** Attach the whip check to the air supply hose, then attach the air supply hose to the machine.
(Check the data plate for the operating pressure range.)
- 6** Connect the staticbond cable to the connector on the hose and then to the target surface.
- 7** Turn air supply on and allow the air hose to pressurize.
- 8** Plug the power cord into an electrical outlet. If an extension cord is necessary, it must comply with the power requirements of this unit and all governing electrical codes.
(Check the data plate for the operating voltage range.)
- 9** Turn the Control Panel Power Switch on.
- 10** Enable the applicator by pushing the Trigger Switch to the ON (I) position. Turn the bleed valve ON (I) to purge water out of the system, then turn it OFF (O) to close it. The unit is now ready to blast. (Note: If water content of compressed air is relatively high, adjust bleed valve so a very small amount of air/water may continuously drain.)

Shut Down

- 1** Stop blasting and push in the Disable Blast Button on the Control Panel.
- 2** Remove unused ice from the hopper.
- 3** Pull out the Disable Blast Button on the Control Panel.
- 4** Flip the Air/Ice Control Switch on the Applicator to Air Only (I) and blast for 1 minute.
- 5** Stop blasting and disable the Applicator Safety by pushing the switch, located on the applicator handle, back to the (O) position.
- 6** Turn OFF the Power Switch.
- 7** Turn OFF the compressed air supply.
- 8** Open the bleed valve to relieve all remaining pressure.
- 9** If open, close the fill lid.
- 10** When the air hose is fully depressurized disconnect the machine.

*When shutting the machine down for more than 15 minutes, always make sure the hopper is empty and blast with air only for 1 minute. Failure to do so may result in feeder and/or nozzle freeze-up.

Aero 40

S E R I E S

MAINTENANCE

Troubleshooting

PROBLEM	CHECK THIS	SOLUTION
Machine will NOT start (GREEN light is not on)	Is the unit plugged in?	If NO...Plug Unit in.
	Is the power switch in the ON (I) position?	If NO...Push power switch to ON (I).
	It still will not start?	Call Cold Jet for support.
Machine will NOT blast	Is the applicator trigger switch pushed back to the (O) position?	If YES...Flip the switch forward to (I).
	Is the air supply connected and the air supply on?	If YES...The nozzle may be clogged, blast with air only to unclog the nozzle.
	Is the incoming air pressure gauge showing pressure?	
	Is the optional pressure regulator open and displaying pressure?	
Is the applicator control cable connected to the machine and the applicator?		
Machine blasts AIR but NOT pellets	Is the Air/Ice Control Switch set to Air ONLY (I)	If YES...Set Air/Ice Control Switch to Air and Ice (II)
	Is the Hopper clogged?	If YES...call Cold Jet for support.
	Is applicator Air/Ice control in (II) position?	If YES...call Cold Jet for support.
	Is a foreign object lodged in the feeder assembly?	If YES...call Cold Jet for support.

Maintenance

BIANNUAL	<ul style="list-style-type: none">• Check pneumatic air lines• Check static bond cable• Check the accessories• Check all valves• Safety test the unit• Check condition of power cord• Check all LEDs• Inspect hoses for damage• Check the pressure gauge• Check for air leaks
MONTHLY	<ul style="list-style-type: none">• Check the air filters by unscrewing the base a 1/4 turn clockwise.• Check the hopper thumper for worn or damaged parts and also check for loose fittings.
WEEKLY	<ul style="list-style-type: none">• Look through the hopper to check the rotor for nicks or gouges.• Make sure the nozzle airflow exit end is not deformed or burred.
DAILY	<ul style="list-style-type: none">• Drain water out of the air filter before using the machine.• While in operation check the pressure gauge for damage.• Check the air and blast hoses for damage (ie: cuts or scuff marks).

Aero 40
S E R I E S

24/7 Customer Service

Cold Jet employs an experienced customer support team to assist you with troubleshooting, maintenance, parts and accessories for your Aero 40 Series system.

General Contact Information

Global Headquarters: +1.513.831.3211 +1.800.777.9101

Latin America: +52 (81) 10 97 0445

Germany: +49 (0) 6551 9606.0

European Headquarters: +32 (0) 13.53.95.47

Office Hours: GMT +1.00

Canada: +1.513.716.6501

Asia +1.513.831.3211 x709

Customer Support After-Hours HOTLINE:

United States/Canada: +1.800.777.9101

Europe: +32 (0) 13 53 94 47

All other locations: +1.513.576.8981

Email:

United States & all other locations:

service@coldjet.com























Europe:

Specifications







Weight (empty)	260 lbs (118 kg)
Dimensions (L x W x H)	36" x 20" x 40" (91.4 cm x 50.8 cm x 101.6 cm)
Dry Ice Capacity	40 lbs (18.1 kg)
Variable Feed Rate	0 - 4 lbs/min (0 - 1.8 kg/min)
Power Requirements:	100 - 140 volts AC 1 Phase (50/60 Hz) 8.2 amps or 200 - 240 volts AC 1 Phase (50/60 Hz) 4.1 amps
Feeder Drive	1/2 HP, AC Motor 1,750 RPM
Blast Pressure Range	Aero 40 HP: 20 - 250 PSI (1.4 - 17.2 bar) Aero 40: 20 - 140 PSI (1.4 - 9.7 bar)
Supply Pressure Range	Aero 40 HP: 65 to 250 PSI (4.5 - 17.2 bar) Aero 40: 65 - 140 PSI (4.5 - 9.7 bar)

Required compressed airflow volume depends on the nozzle being used. Most Cold Jet nozzles need 50 to 180 cfm (1.4 to 5.1 m³/min) at 80 psi (5.5 bar) blast pressure.

Symbol Glossary

	General Danger		Variable feed
	Electric Shock or Electrocutation		Enable Blasting
	Extreme Cold		Disable Blasting
	Hand Crush from Side		Wear Ear Protection
	Hand Cut from Impeller Blade		Wear Eye Protection
	Flying Debris		Read Operator Manual
	Skin Puncture from Pressurized Air Jet		Wear Safety Gloves
	Loud Noise		General Mandatory Action
	Explosive Release of Pressure		Maintain Safe Pressure
	Air Bleed		Do Not Operate with Guard removed
	CO ₂ Only		No Foreign Objects

Symbol Glossary (cont.)

	<p>Lock Out/ Tag Out Before Servicing</p>
	<p>Disconnect Power Before Servicing</p>
	<p>Hour Meter</p>
	<p>Crush Hazard</p>
	<p>Protective Earth/Ground</p>
	<p>Earth/Ground</p>
<p>I</p>	<p>Applicator Trigger Enabled (on bottom of applicator)</p>
<p>I</p>	<p>Air Only</p>
<p>O</p>	<p>Applicator Trigger Disabled</p>
<p>II</p>	<p>Air and Ice</p>

Blast Air Quality

Using Plant Air (Central Compressed Air System)

Manufacturing plants, with central compressed air systems, should have an After Cooler and a 2-stage coalescing filter assembly downstream of the receiver tank. Hot metal pipes are an indication this is needed.

To verify that the plant air system is adequate for your blast system the air compressor needs to produce an air volume 10% greater than the blast machine's maximum air volume...in addition to the air volume consumed by normal plant operation.

To determine adequate air volume, watch the pressure gauge while blasting.

- If the gauge drops slowly the compressor is insufficient.
- If the gauge drops quickly there is a restriction or the pipe is too small.
- If the gauge stays steady then the compressor and piping are adequate.

To maintain adequate pressure to the blast system:

- From the air compressor to 50 ft (15 m) use a flexible 1 in (2.5 cm) air hose (preferably the hose supplied with the machine).
- From the air compressor to beyond 50 ft (15 m) make sure the pipe is 1 in (2.5 cm) in diameter before attaching the air hose.

If an air drop isn't used much, water and rust will collect in the line. Before plugging into the air supply, purge the line, to prevent contamination of the blast system.

Using Portable Air (minimum of 185 cfm - 5.6 m³/min)

Portable diesel air compressors are frequently not optimized for dry ice blasting units and are therefore not configured to cool or remove air moisture.

The After Cooler is required to reduce the discharge air temperature 180°F (82°C) to within 15°F (-9°C) of ambient air temperature. Visit coldjet.com to learn more about purchasing an After Cooler.

Without the After Cooler, the following will occur:

1. Incoming air moisture may rapidly cool and freeze at the feeder.
2. Water ice may accumulate in the feeder, distorting the air flow and seal.

3. Water ice buildup may continue inside the blast hose, to the nozzle.
4. Water ice may break off inside the hose and lodge in the nozzle, causing a jam.
5. Water ice, may exit the nozzle, and damage the target surface.

If blasting continuously, an air dryer will further reduce the air moisture (dew point). Desiccant dryers produce a dew point of -40°F (-40°C), resulting in a dew point low enough for continuous blasting.

To verify the compressor is of adequate size for the Aero, the air compressor needs to produce an air volume 10% greater than the blast system's maximum required air volume.

To determine adequate air volume, blast while watching the pressure gauge.

- If the gauge drops slowly the compressor is insufficient.
- If the gauge drops quickly there is a restriction or the pipe is too small.
- If the gauge stays steady then the compressor is adequate.

To maintain adequate pressure, the hose size from the compressor to the blast system needs to be 1 in (2.5 cm) in diameter.

Warranty Information

Cold Jet® ("CJ") warrants its products ("Equipment") provided under this Agreement to be free from defects in materials and workmanship for a period of 12 months, under normal use, maintenance and service as stipulated in the Operator's Manual. CJ warrants that the equipment will be in good working order on the Date of Shipment and will conform to CJ's official published specifications.

The warranty period is 12 months for CJ manufactured Equipment. Original Equipment Manufacturers' warranties provided by CJ on equipment purchased under this Agreement not manufactured by CJ will be passed through to the Buyer. The warranty period commences on the Date of Shipment of the Equipment.

CJ's liability is limited to repairing or replacing, at its option, any covered part of its Equipment, which CJ has determined to be defective. Said repair or

replacement will be made by CJ or its authorized representative free of charge to the Buyer, except for any freight or travel expenses, during the warranty period. Any replaced part will become the property of CJ. If, after repeated efforts, CJ is unable to restore its Equipment to good working order, or to replace the defective parts as warranted, CJ may, at its discretion, replace the Equipment in its entirety. Any claim must be made to CJ, in writing, within 30 days of discovering the defect and any claim not made within that period shall be deemed waived or released, and thus denied.

Warranty service provided under this Agreement does not assume uninterrupted operation of the Equipment. The suitability of the equipment for the purpose intended is not included in the warranty.

This warranty shall not apply and CJ shall be neither responsible nor liable for:

1. Consequential, collateral or special losses or damages;
2. Equipment conditions caused by abnormal conditions of use, accident, neglect or misuse of equipment, improper storage or damages resulting during shipment as determined by CJ;
3. The replacement of normal wear items, including but not limited to air, blast and whip end hoses;
4. Deviation from the Equipment's prescribed maintenance programs, replacement parts, operating instructions, specifications or other terms of sale;
5. Labor charges, loss or damage resulting from improper operation, maintenance or repairs made by person(s) other than CJ or CJ-authorized service representatives;
6. Improper application of the product. In no event shall CJ be liable for claims in excess of the purchase price, whether there is a breach of contract or warranty claim of negligence or negligent manufacture.

THIS WARRANTY IS THE SOLE WARRANTY OF CJ AND ANY OTHER WARRANTIES, EXPRESS, IMPLIED IN LAW OR IMPLIED BY FACT, INCLUDING ANY WARRANTIES OF MERCHANTABILITY AND FITNESS FOR PARTICULAR USE, ARE HEREBY SPECIFICALLY EXCLUDED.

Global Headquarters

Loveland, OH USA
+1 513.831.3211 US
+1 800.337.9423 International

European Headquarters

Zolder, Belgium
+32 (0)13 53 95 47

Germany

Weinsheim, Germany
+49 (0)6551 96060

Canada

Ontario, Canada
+1 800.337.9423 x501

Latin America

Monterrey, NL Mexico
+52 (81) 10 97 0445

Asia

+1 513.831.3211 x709



Cold Jet.

www.coldjet.com